



INSTALLATION AND SETUP GUIDE
VERSION 2.3

SENSAPHONE[®]
REMOTE MONITORING SOLUTIONS

Sentinel Pro Installation and Setup Guide

Every effort has been made to ensure that the information in this document is complete, accurate and up-to-date. Sensaphone assumes no responsibility for the results of errors beyond its control. Sensaphone also cannot guarantee that changes in equipment made by other manufacturers, and referred to in this manual, will not affect the applicability of the information in this manual.

Copyright © 2015 by SENSAPHONE®

First Edition, version 2.3, June 2024

Written and produced by SENSAPHONE®.

Please address comments on this publication to:

SENSAPHONE®

901 Tryens Road

Aston, PA 19014

Important Safety Instructions

Your Sentinel Pro has been carefully designed to give you years of safe, reliable performance. As with all electrical equipment, however, there are a few basic precautions you should take to avoid hurting yourself or damaging the unit:

- Read the installation and operating instructions in this guide carefully. Be sure to save it for future reference.
- Read and follow all warning and instruction labels on the product itself.
- To protect the Sentinel Pro from overheating, make sure all openings on the unit are not blocked. Do not place on or near a heat source, such as a radiator or heat register.
- Do not use your Sentinel Pro near water, or spill liquid of any kind into it.
- Be certain that your power source matches the rating in the specifications of this manual. If you're not sure of the type of power supply to your facility, consult your dealer or local power company.
- Do not allow anything to rest on the power cord. Do not locate this product where the cord will be abused by persons walking on it.
- Do not overload wall outlets and extension cords, as this can result in the risk of fire or electric shock.
- Never push objects of any kind into this product through ventilation holes as they may touch dangerous voltage points or short out parts that could result in a risk of fire or electric shock.
- To reduce the risk of electric shock, do not disassemble this product, but return it to Sensaphone Customer Service, or another approved repair facility, when any service or repair work is required. Opening or removing covers may expose you to dangerous voltages or other risks. Incorrect reassembly can cause electric shock when the unit is subsequently used.
- If anything happens that indicates that your Sentinel Pro is not working properly or has been damaged, unplug it immediately and follow the procedures in the manual for having it serviced. Return the unit for servicing under the following conditions:
 1. The power cord or plug is frayed or damaged.
 2. Liquid has been spilled into the product or it has been exposed to water.
 3. The unit has been dropped, or the enclosure is damaged.
 4. The unit doesn't function normally when you're following the operating instructions.
- To reduce the risk of fire or injury to persons, read and follow these instructions:
 1. Use only the specified type and size battery.
 2. Do not dispose of the battery in a fire. The cell may explode. Check with local codes for possible special disposal instructions.
 3. Do not open or mutilate batteries. Released electrolyte is corrosive and may cause damage to the eyes or skin. It may be toxic if swallowed.
 4. Exercise care in handling batteries in order not to short the battery with conducting materials such as rings, bracelets, and keys. The battery or conductor may overheat and cause burns.
 5. Remove main power connections before replacing the battery.

FCC Requirements

Part 15: This equipment has been tested and found to comply with the limits for a Class A digital device, pursuant to Part 15 of the FCC Rules. These limits are designed to provide reasonable protection against harmful interference when the equipment is operated in a commercial environment. This equipment generates, uses and can radiate radio frequency energy and, if not installed and used in accordance with the instructions, may cause harmful interference to radio communications. Operation of this equipment in a residential area is likely to cause harmful interference in which case the user will be required to correct the interference at his own expense.

2 YEAR LIMITED WARRANTY

PLEASE READ THIS WARRANTY CAREFULLY BEFORE USING THE PRODUCT.

THIS LIMITED WARRANTY CONTAINS SENSAPHONE'S STANDARD TERMS AND CONDITIONS. WHERE PERMITTED BY THE APPLICABLE LAW, BY KEEPING YOUR SENSAPHONE PRODUCT BEYOND THIRTY (30) DAYS AFTER THE DATE OF DELIVERY, YOU FULLY ACCEPT THE TERMS AND CONDITIONS SET FORTH IN THIS LIMITED WARRANTY.

IN ADDITION, WHERE PERMITTED BY THE APPLICABLE LAW, YOUR INSTALLATION AND/OR USE OF THE PRODUCT CONSTITUTES FULL ACCEPTANCE OF THE TERMS AND CONDITIONS OF THIS LIMITED WARRANTY (HEREINAFTER REFERRED TO AS "LIMITED WARRANTY OR WARRANTY"). IF YOU DO NOT AGREE TO THE TERMS AND CONDITIONS THIS WARRANTY, INCLUDING ANY LIMITATIONS OF WARRANTY, INDEMNIFICATION TERMS OR LIMITATION OF LIABILITY, THEN YOU SHOULD NOT USE THE PRODUCT AND SHOULD RETURN IT TO THE SELLER FOR A REFUND OF THE PURCHASE PRICE. THE LAW MAY VARY BY JURISDICTION AS TO THE APPLICABILITY OF YOUR INSTALLATION OR USE ACTUALLY CONSTITUTING ACCEPTANCE OF THE TERMS AND CONDITIONS HEREIN AND AS TO THE APPLICABILITY OF ANY LIMITATION OF WARRANTY, INDEMNIFICATION TERMS OR LIMITATIONS OF LIABILITY.

- 1. WARRANTOR:** IN THIS WARRANTY, WARRANTOR SHALL MEAN "DEALER, DISTRIBUTOR, AND/OR MANUFACTURER."
- 2. ELEMENTS OF WARRANTY:** THIS PRODUCT IS WARRANTED TO BE FREE FROM DEFECTS IN MATERIALS AND CRAFTSMANSHIP WITH ONLY THE LIMITATIONS AND EXCLUSIONS SET OUT BELOW.
- 3. WARRANTY AND REMEDY:** TWO-YEAR WARRANTY — IN THE EVENT THAT THE PRODUCT DOES NOT CONFORM TO THIS WARRANTY AT ANY TIME DURING THE TIME OF TWO YEARS FROM ORIGINAL PURCHASE, WARRANTOR WILL REPAIR THE DEFECT AND RETURN IT TO YOU AT NO CHARGE.

THIS WARRANTY SHALL TERMINATE AND BE OF NO FURTHER EFFECT AT THE TIME THE PRODUCT IS: (1) DAMAGED BY EXTRANEOUS CAUSE SUCH AS FIRE, WATER, LIGHTNING, ETC. OR NOT MAINTAINED AS REASONABLE AND NECESSARY; OR (2) MODIFIED; OR (3) IMPROPERLY INSTALLED; OR (4) MISUSED; OR (5) REPAIRED OR SERVICED BY SOMEONE OTHER THAN WARRANTORS' AUTHORIZED PERSONNEL OR SOMEONE EXPRESSLY AUTHORIZED BY WARRANTOR'S TO MAKE SUCH SERVICE OR REPAIRS; (6) USED IN A MANNER OR PURPOSE FOR WHICH THE PRODUCT WAS NOT INTENDED; OR (7) SOLD BY ORIGINAL PURCHASER.

LIMITED WARRANTY, LIMITATION OF DAMAGES AND DISCLAIMER OF LIABILITY FOR DAMAGES: THE WARRANTOR'S OBLIGATION UNDER THIS WARRANTY IS LIMITED TO REPAIR OR REPLACEMENT OF THE PRODUCT, AT THE WARRANTOR'S OPTION AS TO REPAIR OR REPLACEMENT. IN NO EVENT SHALL WARRANTORS BE LIABLE OR RESPONSIBLE FOR PAYMENT OF ANY INCIDENTAL, CONSEQUENTIAL, SPECIAL AND/OR PUNITIVE DAMAGES OF ANY KIND, INCLUDING BUT NOT LIMITED TO ANY LABOR COSTS, PRODUCT COSTS, LOST REVENUE, BUSINESS INTERRUPTION LOSSES, LOST PROFITS, LOSS OF BUSINESS, LOSS OF DATA OR INFORMATION, OR FINANCIAL LOSS, FOR CLAIMS OF ANY NATURE, INCLUDING BUT NOT LIMITED TO CLAIMS IN CONTRACT, BREACH OF WARRANTY OR TORT, AND WHETHER OR NOT CAUSED BY WARRANTORS' NEGLIGENCE. IN THE EVENT THAT IT IS DETERMINED IN ANY ADJUDICATION THAT THE LIMITED WARRANTIES OF REPAIR OR REPLACEMENT ARE INAPPLICABLE, THEN THE PURCHASER'S SOLE REMEDY SHALL BE PAYMENT TO THE PURCHASER OF THE ORIGINAL COST OF THE PRODUCT, AND IN NO EVENT SHALL WARRANTORS BE LIABLE OR RESPONSIBLE FOR PAYMENT OF ANY INCIDENTAL, CONSEQUENTIAL, SPECIAL AND/OR PUNITIVE DAMAGES OF ANY KIND, INCLUDING BUT NOT LIMITED TO ANY LOST REVENUE, BUSINESS INTERRUPTION LOSSES, LOST PROFITS, LOSS OF BUSINESS, LOSS OF DATA OR INFORMATION, OR FINANCIAL LOSS, FOR CLAIMS OF ANY NATURE, INCLUDING BUT NOT LIMITED TO CLAIMS IN CONTRACT, BREACH OF WARRANTY OR TORT, AND WHETHER OR NOT CAUSED BY WARRANTORS' NEGLIGENCE.

WITHOUT WAIVING ANY PROVISION IN THIS LIMITED WARRANTY, IF A CIRCUMSTANCE ARISES WHERE WARRANTORS ARE FOUND TO BE LIABLE FOR ANY LOSS OR DAMAGE ARISING OUT OF MISTAKES, NEGLIGENCE, OMISSIONS, INTERRUPTIONS, DELAYS, ERRORS OR DEFECTS IN WARRANTORS' PRODUCTS OR SERVICES, SUCH LIABILITY SHALL NOT EXCEED THE TOTAL AMOUNT PAID BY THE CUSTOMER FOR WARRANTORS' PRODUCT AND SERVICES OR \$250.00, WHICHEVER IS GREATER. YOU HEREBY RELEASE WARRANTORS FROM ANY AND ALL OBLIGATIONS, LIABILITIES AND CLAIMS IN EXCESS OF THIS LIMITATION.

INDEMNIFICATION AND COVENANT NOT TO SUE: YOU WILL INDEMNIFY, DEFEND AND HOLD HARMLESS WARRANTORS, THEIR OWNERS, DIRECTORS, OFFICERS, EMPLOYEES, AGENTS, SUPPLIERS OR AFFILIATED COMPANIES, AGAINST ANY AND ALL CLAIMS, DEMANDS OR ACTIONS BASED UPON ANY LOSSES, LIABILITIES, DAMAGES OR COSTS, INCLUDING BUT NOT LIMITED TO DAMAGES THAT ARE DIRECT OR INDIRECT, INCIDENTAL, SPECIAL OR CONSEQUENTIAL, AND INCLUDING ATTORNEYS FEES AND LEGAL COSTS, THAT MAY RESULT FROM THE INSTALLATION, OPERATION, USE OF, OR INABILITY TO USE WARRANTORS' PRODUCTS AND SERVICES, OR FROM THE FAILURE OF THE WARRANTORS' SYSTEM TO REPORT A GIVEN EVENT OR CONDITION, WHETHER OR NOT CAUSED BY WARRANTORS' NEGLIGENCE.

YOU AGREE TO RELEASE, WAIVE, DISCHARGE AND COVENANT NOT TO SUE WARRANTORS, THEIR OWNERS, DIRECTORS, OFFICERS, EMPLOYEES, AGENTS, SUPPLIERS OR AFFILIATED COMPANIES, FOR ANY AND ALL LIABILITIES POTENTIALLY ARISING FROM ANY CLAIM, DEMAND OR ACTION BASED UPON ANY LOSSES, LIABILITIES, DAMAGES OR COSTS, INCLUDING BUT NOT LIMITED TO DAMAGES THAT ARE DIRECT OR INDIRECT, INCIDENTAL, SPECIAL OR CONSEQUENTIAL, AND INCLUDING ATTORNEYS FEES AND LEGAL COSTS, THAT MAY RESULT FROM THE INSTALLATION, OPERATION, USE OF, OR INABILITY TO USE WARRANTORS' PRODUCTS AND SERVICES, OR FROM THE FAILURE OF THE WARRANTORS' SYSTEM TO REPORT A GIVEN EVENT OR CONDITION, WHETHER OR NOT CAUSED BY WARRANTORS' NEGLIGENCE, EXCEPT AS NECESSARY TO ENFORCE THE EXPRESS TERMS OF THIS LIMITED WARRANTY.

EXCLUSIVE WARRANTY: THE LIMITED WARRANTY OR WARRANTIES DESCRIBED HEREIN CONSTITUTE THE SOLE WARRANTY OR WARRANTIES TO THE PURCHASER. ALL IMPLIED WARRANTIES ARE EXPRESSLY DISCLAIMED, INCLUDING: THE WARRANTY OF MERCHANTABILITY AND THE WARRANTY OF FITNESS FOR A PARTICULAR USE AND THE WARRANTY OF FITNESS FOR A

Sentinel Pro Installation and Setup Guide

PARTICULAR PURPOSE AND THE WARRANTY OF NON-INFRINGEMENT AND/OR ANY WARRANTY ARISING FROM A COURSE OF DEALING, USAGE, OR TRADE PRACTICE.

IT MUST BE CLEAR THAT THE WARRANTORS ARE NOT INSURING YOUR PREMISES OR BUSINESS OR GUARANTEEING THAT THERE WILL NOT BE DAMAGE TO YOUR PERSON OR PROPERTY OR BUSINESS IF YOU USE THIS PRODUCT. YOU SHOULD MAINTAIN INSURANCE COVERAGE SUFFICIENT TO PROVIDE COMPENSATION FOR ANY LOSS, DAMAGE, OR EXPENSE THAT MAY ARISE IN CONNECTION WITH THE USE OF PRODUCTS OR SERVICES, EVEN IF CAUSED BY WARRANTORS' NEGLIGENCE. THE WARRANTORS ASSUME NO LIABILITY FOR INSTALLATION OF THE PRODUCT AND/OR INTERRUPTIONS OF THE SERVICE DUE TO STRIKES, RIOTS, FLOODS, FIRE, AND/OR ANY CAUSE BEYOND SELLER'S CONTROL, FURTHER SUBJECT TO THE LIMITATIONS EXPRESSED IN ANY LICENSE AGREEMENT OR OTHER AGREEMENT PROVIDED BY WARRANTORS TO PURCHASER.

THE AGREEMENT BETWEEN THE WARRANTORS AND THE PURCHASER, INCLUDING BUT NOT LIMITED TO THE TERMS AND CONDITIONS HEREIN SHALL NOT BE GOVERNED BY THE CONVENTION FOR THE INTERNATIONAL SALE OF GOODS. WHERE APPLICABLE, THE UNIFORM COMMERCIAL CODE AS ADOPTED BY THE STATE OF DELAWARE SHALL APPLY.

4. PROCEDURE FOR OBTAINING PERFORMANCE OF WARRANTY: IN THE EVENT THAT THE PRODUCT DOES NOT CONFORM TO THIS WARRANTY, THE PRODUCT SHOULD BE SHIPPED OR DELIVERED FREIGHT PREPAID TO A WARRANTOR WITH EVIDENCE OF ORIGINAL PURCHASE.

5. LEGAL REMEDIES AND DISCLAIMER: SOME JURISDICTIONS MAY NOT ALLOW, OR MAY PLACE LIMITS UPON, THE EXCLUSION AND/OR LIMITATION OF IMPLIED WARRANTIES, INCIDENTAL DAMAGES AND/OR CONSEQUENTIAL DAMAGES FOR SOME TYPES OF GOODS OR PRODUCTS SOLD TO CONSUMERS AND/OR THE USE OF INDEMNIFICATION TERMS. THUS, THE EXCLUSIONS, INDEMNIFICATION TERMS AND LIMITATIONS SET OUT ABOVE MAY NOT APPLY, OR MAY BE LIMITED IN THEIR APPLICATION, TO YOU. IF THE IMPLIED WARRANTIES CAN NOT BE EXCLUDED, AND THE APPLICABLE LAW PERMITS LIMITING THE DURATION OF IMPLIED WARRANTIES, THEN THE IMPLIED WARRANTIES HEREIN ARE TO BE LIMITED TO THE SAME DURATION AS THE APPLICABLE WRITTEN WARRANTY OR WARRANTIES HEREIN. THE WARRANTY OR WARRANTIES HEREIN MAY GIVE YOU SPECIFIC LEGAL RIGHTS THAT WILL DEPEND UPON THE APPLICABLE LAW. YOU MAY ALSO HAVE OTHER LEGAL RIGHTS DEPENDING UPON THE LAW IN YOUR JURISDICTION.

6. CHOICE OF FORUM AND CHOICE OF LAW: IN THE EVENT THAT A DISPUTE ARISES OUT OF OR IN CONNECTION WITH THIS LIMITED WARRANTY, THEN ANY CLAIMS OR SUITS OF ANY KIND CONCERNING SUCH DISPUTES SHALL ONLY AND EXCLUSIVELY BE BROUGHT IN EITHER THE COURT OF COMMON PLEAS OF DELAWARE COUNTY, PENNSYLVANIA OR THE UNITED STATES DISTRICT COURT FOR THE EASTERN DISTRICT OF PENNSYLVANIA.

REGARDLESS OF THE PLACE OF CONTRACTING OR PERFORMANCE, THIS LIMITED WARRANTY AND ALL QUESTIONS RELATING TO ITS VALIDITY, INTERPRETATION, PERFORMANCE AND ENFORCEMENT SHALL BE GOVERNED BY AND CONSTRUED IN ACCORDANCE WITH THE LAWS OF THE STATE OF DELAWARE, WITHOUT REGARD TO THE PRINCIPLES OF CONFLICTS OF LAW.

Effective date 02/25/2015

PHONETICS, INC. d.b.a. SENSAPHONE

901 Tryens Road

Aston, PA 19014

Phone: 610.558.2700 Fax: 610.558.0222

www.sensaphone.com

TABLE OF CONTENTS

CHAPTER 1: INSTALLATION	9
INTRODUCTION	9
FEATURES	9
TECHNICAL SUPPORT	9
ABOUT THIS MANUAL	10
INSTALLATION AND CONFIGURATION	10
PHYSICAL DESCRIPTION	10
LAYOUT	10
SENSOR INPUTS	10
POWER LED (GREEN)	10
ALARM LEDS (RED)	10
ONLINE LED (GREEN)	10
STANDBY LED (YELLOW)	11
ACKNOWLEDGE/ STANDBY BUTTON	11
INSTALLATION	11
PARTS REQUIRED	11
OPERATING ENVIRONMENT	11
POWER	11
CELLULAR ACTIVATION	11
ANTENNA INSTALLATION	11
SENTINEL CELLULAR VERSION	12
WALL MOUNT INSTALLATION	13
TURNING THE UNIT ON	14
TURNING THE UNIT OFF	14
POWER SUPPLY	14
CONNECTING SENSORS	15
GENERAL WIRING CONSIDERATIONS	15
NORMALLY OPEN / NORMALLY CLOSED DRY CONTACTS	16
2.8K/10K TEMPERATURE SENSORS	16
4-20MA CURRENT LOOP TRANSDUCERS	17
RELAY OUTPUT WIRING	17
BATTERY BACKUP	18
MEMORY/CLOCK BATTERY	18
RESETTING THE SENTINEL PRO TO FACTORY DEFAULT SETTINGS	18
CHAPTER 2: SET UP	19
DESCRIPTION OF WEB PAGES	19
DASHBOARD	19
DEVICE DETAILS	21
CONFIGURE DEVICE	21
ZONE PARAMETER DEFINITIONS	23

MANAGE USERS	24
MANAGE USER GROUPS	26
ALARM DELIVERY	26
LOGS	28
DEVICE MANAGEMENT	28
DEVICE GROUPS	29
CHAPTER 3: CONFIGURING THE RELAY OUTPUTS	30
RELAY OUTPUT WIRING	31
CHAPTER 4: MODBUS	32
READING MODBUS OVER RS485	32
MODBUS ZONE SETUP	34
CONNECTING MODBUS RS-485 DEVICES TO YOUR SENTINEL PRO	36
APPENDIX A: WEEKLY TESTING PROCEDURE	38
APPENDIX B: ACCESSORIES	39
APPENDIX C: SPECIFICATIONS	40
ALERT ZONES	40
RELAY OUTPUT	40
DATA LOGGING	40
COMMUNICATION TYPE:	40
POWER SUPPLY	40
BATTERY BACKUP	41
CELLULAR BATTERY: 3AH SLA BATTERY (PART-0005)	41
ENVIRONMENTAL	41
PHYSICAL	41
APPENDIX D: THERMISTORS	42
2.8K THERMISTOR DATA	42
10K THERMISTOR DATA	42
APPENDIX E: RETURNING THE UNIT FOR REPAIR	43
APPENDIX F: TEST LOG	44

CHAPTER 1: INSTALLATION

INTRODUCTION

Congratulations on your purchase of the Sentinel Pro Monitoring System. The system is designed to be an easy, cost-effective, cloud-based monitoring and data logging system to notify you when equipment or conditions go awry. The internet browser-based programming makes the device easy to use from any computer or tablet. Monitored conditions can include temperature, humidity levels, pressure, flow, leak detection, UPS systems, and more. The Sentinel Pro allows you to read up to 64 Modbus registers from third party equipment so that you can create alarms, view the values over the internet, and record the values for trending purposes. The Sentinel Pro can read the values over 2-wire RS485 or Ethernet/TCP. You can also read registers from both interfaces simultaneously, if desired. The system allows multiple users to be notified immediately of any detected problems. Notification can occur via voice call, e-mail or SMS (text message). The internal battery backup system insures the unit will continue to run if main power fails.

FEATURES

The Sentinel Pro includes the following key features:

- Twelve universal digital or analog sensor inputs to monitor environmental conditions and/or alarm contacts from other equipment.
- Up to 64 Modbus registers can be read from third-party equipment via 2-wire RS485 or Ethernet/TCP.
- Battery backup for uninterrupted performance
- Notification via e-mail, text message and voice call
- Relay output capable of automatic or manual control
- Cloud-based user interface for programming, data storage, and alarm delivery
- Weatherproof NEMA 4X enclosure
- Cellular modem available for AT&T, Verizon or Rogers service

TECHNICAL SUPPORT

If any questions arise upon installation or operation of the Sentinel Pro, please contact the Sensaphone Technical Service Department at 610.558.2700 and have the following information available:

- Date of purchase _____
- Serial number _____

Technical support is available from 8:00 AM to 5:00 PM, M-F, eastern time.

ABOUT THIS MANUAL

This manual comprises the instructions necessary to install and setup the Sentinel Pro. You should thoroughly read this manual to establish a basic understanding of the system and keep it as a reference.

INSTALLATION AND CONFIGURATION

PHYSICAL DESCRIPTION

The Sentinel Pro is housed in a 14" x 12" x 7.4" enclosure, which can be easily mounted on a wall or back panel.

LAYOUT

The Sentinel Pro has connections for twelve sensor inputs, two relay outputs, an Ethernet port, and 12VDC power. See figure below:



Figure 1: Front Panel Layout of the Sentinel Pro

- | | |
|--------------------------------|---------------------------------|
| 1) Acknowledge/Standby Button | 7) Ethernet Jack |
| 2) On/Off Switch | 8) Sensor Input Terminal Strip |
| 3) Power, Online, Standby LEDs | 9) Relay Outputs |
| 4) Alarm LEDs | 10) Modbus RS485 Terminal Strip |
| 5) Relay Output LEDs (yellow) | 11) Battery Backup Module |
| 6) Power Jack | 12) Cellular Modem |

SENSOR INPUTS

The sensor inputs labeled zones 1-12 are designed to interface with normally open/normally closed devices, 2.8K or 10K temperature sensors and 4-20mA transducers.

POWER LED (GREEN)

This light indicates that the Sentinel Pro unit is powered and operational.

ALARM LEDS (RED)

The Alarm LEDs indicate if an alarm exists.

ONLINE LED (GREEN)

This light indicates that the Sentinel Pro unit is communicating with the Sentinel Pro servers.

STANDBY LED (YELLOW)

This light indicates that the Sentinel Pro unit is in standby mode.

ACKNOWLEDGE/ STANDBY BUTTON

When an unacknowledged alarm exists (as indicated by a blinking red alarm LED), briefly press the button and the alarm LED will stop blinking, indicating that the alarm is acknowledged. To enter Standby mode, press and hold the button for at least 5 seconds until the Standby LED lights up, then release. To exit from Standby mode, hold the button down for 5 seconds until the Standby LED turns off.

INSTALLATION

This section provides information on:

- Operating environment
- Installation
- Connecting sensors
- Network Configuration

PARTS REQUIRED

- Screwdriver and #8 screws
- Computer w/Internet Connection

OPERATING ENVIRONMENT

Before you install the Sentinel Pro be sure that your operating environment meets the physical requirements of the equipment.

Operating Temperature:	32° – 122° Fahrenheit (0° – 50° C)
Humidity:	5 – 90 %RH, non-condensing
Power:	115VAC 50/60 Hz outlet within 6'

POWER

Plug the power adapter into a 115V AC power outlet.

CELLULAR ACTIVATION

This device requires activation on the cellular network to operate. Fill-out the subscription registration form included with device and send to it Sensaphone to complete the activation process. Once it is activated power-up the device and allow a few minutes for the Sentinel to boot-up and for the modem to connect to the cellular network. Make sure the Online LED glows steadily, indicating that the device is communicating with Sensaphone.net server system. Once its online you will be able to access the device through the Sensaphone.net website.

ANTENNA INSTALLATION

Bracket Mounting - Select a suitable mounting location for the antenna on the desired surface. The orientation of the antenna should be vertical with the cable exiting downwards. When selecting a mounting location care should be taken to ensure that at least 300mm (12") of separation is maintained between the antenna and nearby metal objects and surfaces.

When mounting the antenna to a metal housing, device enclosure or mast, care should be taken to ensure that the antenna housing is elevated above the metal surface to which it is mounted. Ensure that the selected location will enable the coaxial cable to be easily routed to the equipment. If mounting the antenna using screws it is important to check for adequate under panel clearance. It is important for RF performance that the antenna is only bracket mounted using the supplied bracket. Mounting the antenna utilizing a different bracket may adversely affect performance. The antenna can be mounted via the four 4.5mm fixing holes (suitable for M4 machine screws or 4mm self-tapping screws) or mast mounted using a jubilee or worm drive hose clip with a maximum width of 14mm (1/2"). If you will be drilling holes to mount the antenna, the bracket can be used as a drilling template.

When ready, mount the antenna securely to the bracket using the supplied nut and washer. It is not necessary to remove the backing from the supplied adhesive pad but the pad can be utilized if a more permanent fitment to the bracket is desired. If utilizing the adhesive pad, ensure that the top surface of the bracket is clean and dry, remove the backing from the adhesive pad and stick the antenna to the bracket applying firm pressure.

Panel Mounting - Select a suitable location. The antenna must be fitted to a conductive ground plane of adequate size. It will fit panels of between 1-12mm thick (0.04-0.47"). The recommended minimum diameter of the surface is 200mm (8"). Select a mounting location taking care to ensure that there is at least 300mm (12") of clearance from proximate metal objects. Ensure that there is adequate clearance under the mounting panel and measure to check for central positioning if necessary. Mask the panel area around the hole position to protect the surface / paintwork. Drill a pilot hole, then increase the hole size to 14mm (0.55"), ensuring that the drill / cutter bit does not hit any objects under the panel. Clean the area around the hole carefully removing all swarf. Remove any paint and primer from underneath the panel surface to ensure adequate electrical contact using washer and nut. Remove the nut and washer and then the adhesive pad backing from the underside of the antenna and feed the coaxial cable through the panel. Position the antenna over the mounting hole and stick it to the panel applying firm pressure. Assemble the nut and washer from under the panel and tighten fully.

Routing The Coaxial Cable - Route the coaxial cable to the Sentinel, taking care to avoid running adjacent to existing wiring or fouling any moving controls or components.

SENTINEL CELLULAR VERSION

The Cellular version of the Sentinel Pro includes a 4G modem and battery backup system to keep the entire unit functioning for up to 8 hours. A special Battery Backup Controller is included to maintain proper charging of the 12V backup battery and automatically switchover when power fails. The unit is packaged in a NEMA-4X Polycarbonate enclosure with a universal 12V power supply. Cellular subscription plans are available from Sensaphone.

WALL MOUNT INSTALLATION

The NEMA 4X enclosure (14" x 12" x 7.4") comes with mounting feet that must be attached to the bottom of the enclosure. The drawing below shows the location of the mounting feet for attaching the enclosure to a wall:

Mounting Dimensions (Cellular):

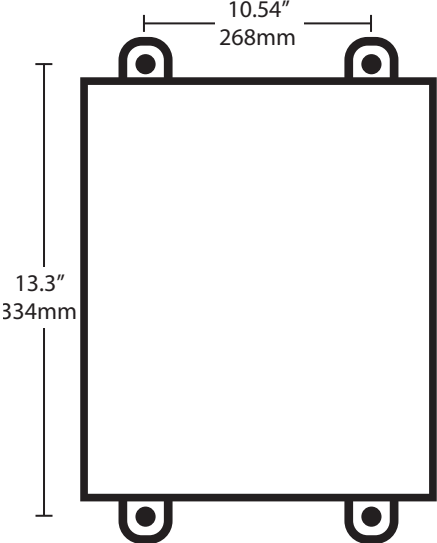

TURNING THE UNIT ON

To power-up the system, plug-in the power supply and turn-on the power switch on the front of the Sentinel Pro.

TURNING THE UNIT OFF

To power-down the system, turn-off the power switch on the front of the Sentinel Pro, unplug the power supply, and then briefly press the OFF button on the Cellular Battery Backup Controller. This will disconnect the battery backup system and the unit will shutdown.



POWER SUPPLY

The unit comes with an external 12VDC 2A power supply that accepts 100-240VAC 50/60Hz. The power supply has been prewired to the Cellular Battery Backup Controller located inside the enclosure. This controller distributes power to the Sentinel Pro, the cellular modem, and also controls the battery backup system for the cellular modem. Note that the Sentinel Pro has its own internal rechargeable battery.

CELLULAR BATTERY BACKUP CONTROLLER

The Cellular Battery Backup Controller is the main power input for the system. It distributes power to the Sentinel Pro, the cellular modem, and controls the cellular battery backup system. There is no on/off switch for the controller, once power is applied it is functioning. Note that the modem also does not have a power switch so the modem will turn-on immediately as well. Only the Sentinel Pro has its own power switch.

CELLULAR BATTERY BACKUP

There is a 12V 3AH rechargeable battery located below the Sentinel Pro which is used to power the cellular modem in the event of a power failure. The entire system should operate for about 8 hours when the batteries are fully charged. The 12V battery should last for 4-5 years before needing replacement depending on usage and operating temperature.

SOLAR OPERATION

To operate the unit from a solar power system, disconnect the external power supply from the Vin terminals on the Cellular Battery Backup Controller. Next, connect the output of the solar voltage regulator to the Vin terminals. (See specifications for requirements)

CONNECTING SENSORS

The Sentinel Pro is compatible with a wide variety of sensors including normally open/normally closed contacts, 2.8K and 10K temperature sensors, and 4–20mA current sources. Compatible sensors and accessories are shown on the Sentinel Pro website. Sensors may be connected while the device is powered on or off. A proper size screwdriver is provided for your convenience. Contact Sensaphone or your Sensaphone reseller for assistance in selecting sensors for your monitoring requirements. A list of sensors and accessories is shown in Appendix B. Follow the instructions below to properly wire and configure the inputs for each type of electrical signal.

Warning: The inputs are designed to work with low voltage signals. DO NOT connect voltages greater than 3.3V to the inputs. DO NOT connect 120VAC to the inputs.

GENERAL WIRING CONSIDERATIONS

Most dry contact sensors can be connected to the Sentinel Pro using inexpensive 2-conductor twisted-pair cable as small as #24 AWG. For temperature and 4–20mA sensors, use the wire chart below as a reference for selecting the appropriate wire gauge. Note that if the sensor is located far from the unit or if you are running cable in an electrically noisy environment, you should seriously consider using shielded cable. This will shield the signal from electrical interference, thereby preventing false readings and/or damage to the unit. For your convenience, Sensaphone has 22 gauge shielded cable available in 50' lengths (part number FGD-0010). To minimize electrical noise coupling between sensor wires and other wiring, follow the guidelines listed below:

- Route the power supply and network cables to the unit by a separate path then the wiring to the sensor inputs. Where paths must cross, their intersection should be perpendicular.
- Do not run sensor wiring and AC power in the same conduit.
- Segregate wiring by signal type. Bundle wiring with similar electrical characteristics together.
- If shielded cable is used, tie the shield to the input ground terminal.

<u>Wiring Distance</u>	<u>Minimum Wire Gauge</u>
700'	#24 AWG
1500'	#22 AWG
2500'	#20 AWG

Sentinel Pro Installation and Setup Guide

The zone terminal strip has an upper and lower level for connecting up to 12 sensors. The lower level terminals are all “ground” and are electrically connected together. The upper terminal strip is the positive connection for each sensor. See illustration below.

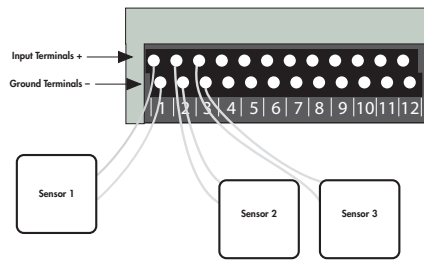

NORMALLY OPEN / NORMALLY CLOSED DRY CONTACTS

Dry contact sources consist of alarm relays or switches that are isolated and have no external voltage applied. These devices can be connected directly to the zone terminals without regard for polarity. Choose a zone and connect the wires to the corresponding screw terminals for that zone. The following figure shows how to connect a dry contact sensor:

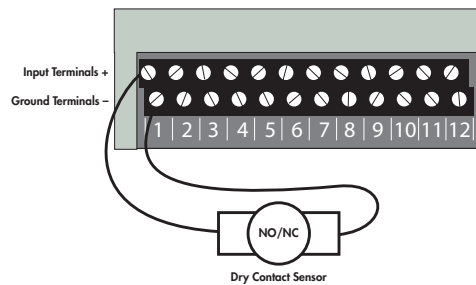

Wiring a Dry Contact Sensor

2.8K/10K TEMPERATURE SENSORS

The Sentinel Pro is compatible with 2.8K/10K temperature sensors that match the curve data listed in the tables in Appendix D. The monitoring temperature range of the 2.8K thermistor is -109 to 115°F (-85° to 57°C) and the 10K thermistor is -87° to 168°F (-66° to 76°C). Temperature sensors can be connected directly to the zone terminals without regard for polarity. Choose an alarm input and connect the wires to the corresponding screw terminals for that zone. 2.8K and 10K temperature sensors are available from Sensaphone. See Appendix B for part numbers. The figure below shows how to connect a temperature sensor:

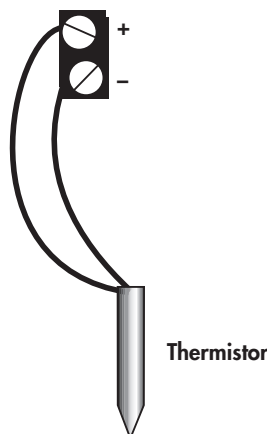

Wiring a Temperature Sensor

4–20mA CURRENT LOOP TRANSDUCERS

The inputs on the Sentinel Pro are compatible with transducers that produce an analog output current of 4 to 20mA. Such transducers are available to measure tank and well levels, extreme temperatures, air pressure, water pressure, flow, voltage, current, rotational speed, etc. Contact our technical support department for assistance regarding your monitoring requirements (877-373-2700 or support@sensaphone.com). Follow the wiring diagrams below for connecting a 4–20mA device:

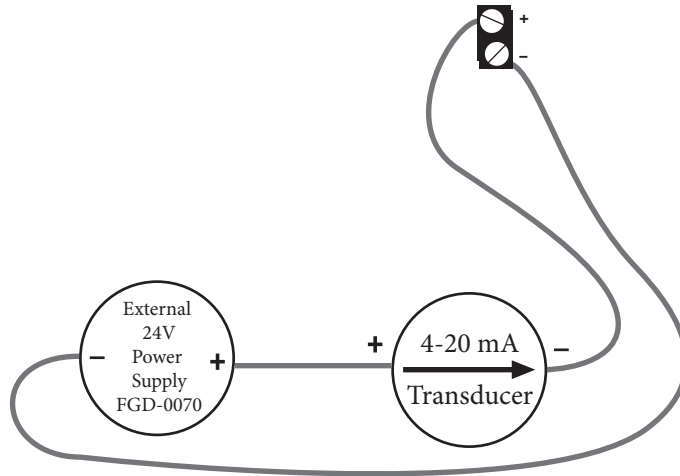

Wiring a 4–20mA device using an external 24 VDC supply.

RELAY OUTPUT WIRING

The Sentinel Pro includes two relay outputs (switches) that can be used to turn on a light, siren, or other device whenever an alarm occurs. The output are normally–open (i.e. off) dry contacts that can be used for low voltage switching. The relays are rated for up to 30VAC/VDC 1 Amp. A sample wiring diagram is shown below:

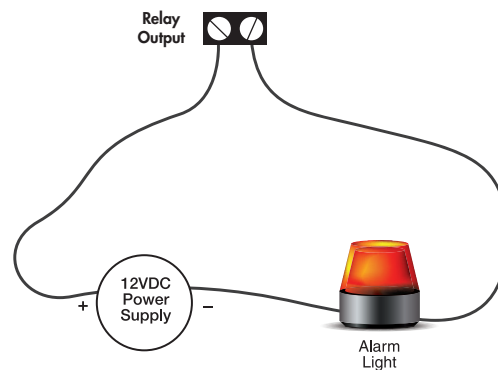

The relays can be controlled manually (via the website or App) or automatically based on specific inputs or alarms. See chapter 3 for details.

BATTERY BACKUP

The Sentinel Pro (inside the white metal enclosure) has an internal rechargeable battery backup pack (part #FGD-0032) which will provide up to 8 hours of backup time in the event of a power failure. The unit will charge the battery and monitor its charge level. The percent charge can be viewed on the website. The Sentinel Pro contains circuitry to protect the battery from deep discharge damage and will disconnect the battery when all of its available energy has been expended. The battery backup module should last 4 to 5 years.



To replace the battery pack, switch the power off, then remove the four screws on either side of the enclosure. The cover contains two switches with wires attached, carefully lift the cover off and move it out of the way without disconnecting any of the wires. Disconnect the battery connector with the red & black wires by pulling it out. Next, loosen the velcro strap and remove the battery pack. Install the new battery pack and secure the Velcro strap. Insert the battery connector into the circuit board (it doesn't matter which way you insert it). Carefully replace the cover making sure all of the leds pop through the holes, then replace the four screws.

MEMORY/CLOCK BATTERY

The Sentinel contains a CR2 lithium battery (inside the white metal enclosure) to backup certain values in SRAM memory as well as the real-time clock. This battery should last between 5-10 years depending on how much time the device is powered off.

RESETTING THE SENTINEL PRO TO FACTORY DEFAULT SETTINGS

In the event that you can no longer connect to your Sentinel Pro, you can reset the unit to factory defaults. On the back of the unit is a small hole. Beneath the hole is a push button. Insert a paper clip or similar item into the hole and push the button for 5 seconds while the device is powered on. The Sentinel will erase all of its programming and then reboot automatically. Alternatively you can also reset the device to defaults from the Sensaphone.net website. Go to the Manage Devices page, under the Admin menu. Select the device, choose Reset to Default Values from the drop down, and click Submit.

CHAPTER 2: SET UP

When your Sentinel Pro “Online” LED is lit you can continue with the following website section.

1. Open an internet browser and go to www.sensaphone.net.
2. Fill in the form to create a new account.

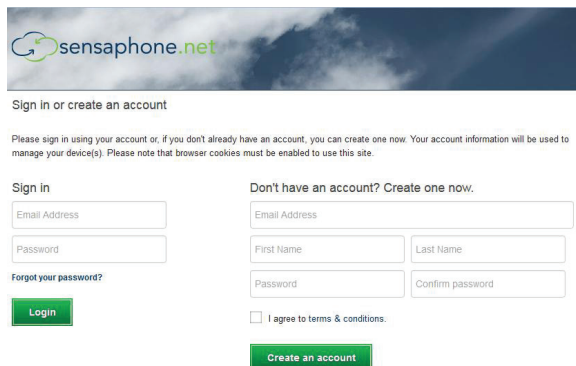

The screenshot shows the Sensaphone.net website header with the logo and the text "sensaphone.net". Below the header, there is a navigation bar with "Dashboard", "Users", and "Admin" options. The main content area is titled "Manage Devices" and contains two sections: "Your Devices" and "Add a Device".

Sign in or create an account

Please sign in using your account or, if you don't already have an account, you can create one now. Your account information will be used to manage your device(s). Please note that browser cookies must be enabled to use this site.

Sign in

Email Address
 Password
 Forgot your password?
 Login

Don't have an account? Create one now.

Email Address
 First Name
 Last Name
 Password
 Confirm password
 I agree to terms & conditions.
 Create an account

3. Once you are logged in, click *Admin*, then *Manage Devices*. In the “Add a Device” section, enter the Serial Number of your Sentinel Pro and enter a device name. Click the *Add Device* button when finished.

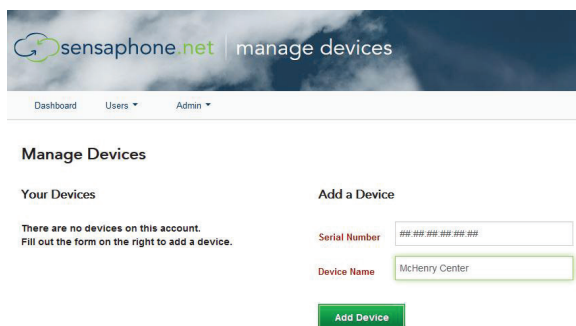

The screenshot shows the Sensaphone.net website header with the logo and the text "sensaphone.net | manage devices". Below the header, there is a navigation bar with "Dashboard", "Users", and "Admin" options. The main content area is titled "Manage Devices" and contains two sections: "Your Devices" and "Add a Device".

Manage Devices

Your Devices

There are no devices on this account.
 Fill out the form on the right to add a device.

Add a Device

Serial Number
 Device Name
 Add Device

Your Sentinel Pro is now online with the Sensaphone.net website. Read the section below to learn how to view status and program your device.

DESCRIPTION OF WEB PAGES

DASHBOARD

The dashboard will list all of the devices on your account. This page is automatically updated with the most current information available.

The numbers at the top will show how many Unacknowledged Alarms, Current Alarms, Units Online, and Units Offline that currently exist for all devices on your account.

The map will show the location of any device on your account that has an address or GPS location listed. You can hover over the icon to see the device name and status. If the icon for the device is green, your device status is OK. If it is red, your device has alarms. You can click on the icon to show the zone values for the selected device.

The screenshot shows the Sentinel Pro Dashboard. At the top, there are four summary statistics: Unacknowledged Alarms (0), Total Alarms (2), Units Online (5), and Units Offline (0). Below this is a map of the Northeastern United States with several device location markers. A table below the map lists the following devices:

Device Name	Status	Power	Battery	Last Response
Acme Waste/Water Treatment Plant	Alarms	On	100%	Online
Acme Wet Well Alarm	Okay	On	100%	Online
PHL Water Plant	Okay	On	100%	Online
River Road Pump Station	Okay	On	100%	Online
Valley Forge Booster Station	Okay	On	100%	Online

The device table will display all devices on your account. Click on the *Details* button to display and configure the zones for that device. You can also use the search box above the table to search through the table, or click on the table column headers to sort the data.

Device Name – The name of the device

Status – The current status of the device (Okay, Alarms, Offline, or Standby) If the device has any unacknowledged alarms, a symbol will be displayed in this column

Power – Displays if the device is On or Off (--- will display if the device is offline)

Battery – The current percentage of the device battery (--- will display if the device is offline)

Last Response – The time that the device last connected to the server

Standby Mode

Standby mode puts the Sentinel Pro in a temporary state such that no alarms will be detected, allowing onsite personnel to perform maintenance or other tasks that may have triggered an alarm otherwise. Standby mode can be entered using the Action drop down on the Dashboard page or via the pushbutton on the front of the unit. Standby mode will persist for the duration of time entered on the Device Configure screen and will automatically exit once the time expires. When using the pushbutton you must depress the button for 5 seconds. The Standby LED will light up to indicate that the device is in Standby mode. You can also exit Standby mode using the same methods.

Standby – Allows you to put the selected devices into Standby mode

Enter – Put the Sentinel Pro in Standby mode for the length of time that is set on the Device Configure page

Enter (Untimed) – Put the Sentinel Pro in Standby mode until you disable it

Exit – Take the device out of Standby mode

DEVICE DETAILS

The device details page displays the sensor values for your Sentinel Pro. This page is automatically updated with the most current information available. At the top of the page are buttons to access the *Configuration*, *Alarm Delivery* and *Logs*.

Action	Zone #	Zone Name	Status	Value	Min	Max
<input type="checkbox"/>	--	Power	OK	On	--	--
<input type="checkbox"/>	--	Battery	OK	100%	100%	100%
<input type="checkbox"/>	--	Lithium Battery	OK	100 %	100 %	100 %
<input type="checkbox"/>	1	Boiler Room Temp	OK	92.000	92.000	92.000
<input type="checkbox"/>	2	Sever Room Temp	OK	68.000	68.000	68.000
<input type="checkbox"/>	3	Water Pressure	OK	55.000	55.000	55.000
<input type="checkbox"/>	4	Sprinkler Room Temp	OK	85.000	85.000	85.000
<input type="checkbox"/>	5	Warehouse Lights	OK	Off	--	--
<input type="checkbox"/>	6	Dock Door #1	OK	Closed	--	--
<input type="checkbox"/>	7	Dock Door #2	OK	Closed	--	--
<input type="checkbox"/>	8	Dock Door #3	OK	Closed	--	--
<input type="checkbox"/>	9	Sump Leak	OK	OK	--	--
<input type="checkbox"/>	10	Water Heater Leak	OK	OK	--	--
<input type="checkbox"/>	11	North Air Handler Water Leak	OK	OK	--	--
<input type="checkbox"/>	12	South Air Handler Water Leak	OK	OK	--	--
<input type="checkbox"/>	MB1	Power Consumption	OK	15172.000 KWH	15172.000 KWH	15172.000 KWH
<input type="checkbox"/>	MB2	Phase A Voltage	OK	208.000 VAC	40.000 VAC	208.000 VAC

At the top of the page, you will see the device name, description, address and alarm status.

You will also see all of the zones for your device in the table.

Zone – The name of the zone

Value – The current value of the zone

Status – The current status of the zone

Min/Max – Displays the highest and lowest values recorded

If the device has any unacknowledged alarms, a symbol will be displayed in this column

The Action dropdown menu provides options that allow you to interact with your device such as acknowledging alarms, resetting pulse count, runtime and min/max values, and putting the device into standby mode.

CONFIGURE DEVICE

At the top of the dashboard, click *Configure Device* to go to the device and zone programming screens. The box on the left will display all of your configureable zones, as well as Device (for general device settings), Power, Battery and Relay Outputs. As you select an option, the form on the right will change to display the appropriate data. Complete the address so that the Sentinel Pro icon will be displayed at the appropriate location on the dashboard map. The gps coordinates will be automatically computed based on the address you enter after you click Save. If the computed coordinates are off you can override them by entering your own. To have the coordinates recompute based on the address you must delete them, then click Save again.

This page also contains settings for the *Device Offline* alarm and for *Standby Mode*. The *Device Offline* alarm will notify you if your devices stop communicating with the sensaphone.net servers for the programmed time duration. You can also receive a notification when the device comes back online by enabling the “Offline Return-To-Normal” option. You can create a custom list of people to be notified specifically for offline alarms by selecting the “Offline Alarm Delivery tab” at the top of this section and choosing Custom Alarm Delivery.

Once you have completed your programming, click on the *Save Settings* button at the bottom of the page.

The screenshot displays the configuration interface for a Sentinel Pro device. On the left is a sidebar menu with options: Device, Power, Battery, 1: High Sump Level, 2: Flow Rate, 3: Ambient Temperature, 4: Generator Fuel Level, 5: Security Door, 6: Leak Detector, 7: pH, 8: Dissolved Oxygen, 9: Sp Conductance, 10: Salinity, 11: Turbidity, 12: Total Flow Output. The main content area is titled 'Sentinel Demo' and 'Offline Alarm Delivery', with an 'Audit Log Links OFF' button in the top right. The 'Device Status' is 'Okay'. The 'Device Information' section includes fields for Name (Sentinel Demo), Description (Water Treatment System), and a Google-powered address autocomplete field. The address is 6001 W Pershing Rd, Cicero, Illinois 60804. GPS coordinates are 41.821498 latitude and -87.772889 longitude. The 'Device Settings' section shows Standby Time (1 Hour), Offline Timeout (30 minutes), and Offline Return To Normal (Enable selected). The 'IP Settings' section has a checked checkbox for DHCP.

Serial Number	00-07-F9-00-82-A3	Device Status:	Okay
Firmware	v1.7.32		
Subscription	Premium		

Device Information

Name: Sentinel Demo

Description: Water Treatment System

Address Line 1: 6001 W Pershing Rd

Address Line 2: Address Line 2

City: Cicero

State/Subdivision: Illinois

Postal Code: 60804

Country: Country

GPS Coordinates: 41.821498 latitude -87.772889 longitude

Timezone: Central Time

Device Settings

Standby Time: 1 Hour

Offline Timeout: 30 minutes

Offline Return To Normal: Enable Disable

Note: Offline timeout will notify users when the device has stopped communicating with the cloud. [More Info](#)

IP Settings

DHCP

Zone Programming

Select the zone you would like to configure from the box from the left. A sample screen for a temperature sensor is shown below.

The screenshot displays the configuration interface for a temperature sensor. On the left, a list of devices is shown, with '3: Ambient Temperature' selected. The main configuration area is divided into two tabs: 'Ambient Temperature' and 'Zone Alarm Delivery'. The 'Ambient Temperature' tab shows a current value of 82.7F and options to enable or disable the zone. The 'Zone Alarm Delivery' tab shows settings for recognition time (0 hours, 0 minutes, 3 seconds), alarm hold time (0 minutes, 1 second), return to normal (Disable), auto acknowledge (Disable), and alarm reset (Disable, 0 hours, 0 minutes). The 'Datalog Settings' section includes mode (Continuous, While in Alarm, Disabled), alarm interval (0 hours, 15 minutes), and normal interval (0 hours, 30 minutes). A 'Save Changes' button is located at the bottom.

ZONE PARAMETER DEFINITIONS

Enable/Disable: This setting determines if the Zone is being used (Enabled) or not (Disabled). Selecting Disabled will remove the gauge from the Summary screen.

Name: Enter a name for the sensor you are monitoring which describes its purpose and/or location. The name will appear on the Device Details screen as well as on alarm messages.

Type: Choose the type of sensor you are connecting to the Zone input. For temperature sensors choose either degrees F or C.

Units: The Units field is used to describe the units of measure for the value being monitored. When Temperature is selected the Units field will automatically display F (Fahrenheit) or C (Celsius). When a 4-20mA type is selected you can enter the appropriate text for the monitored condition (e.g. %RH, PSI, GPM, RPM,...). When you select Normally Open (NO) or Normally Closed (NC) you can choose from several preset descriptions for the Open and Closed state of the input. The first word always describes the Open state of the contact and the second the Closed state. If you choose Custom you can enter your own text for the Open and Closed states. To do this simply type the words into the lower Units field and separate them with a slash (/). For example, “Slow/Fast”, “Safe/Danger”, “Dry/Wet”.

Calibration: This field can be used to offset the Zone value either positive or negative if there is some error in the reading.

Alarm Low: This is used to determine the low level at which a temperature or 4–20mA Zone has reached the alarm threshold. The value must fall below the Alarm Limit to trip an alarm.

Alarm High: This is used to determine the high level at which a temperature or 4–20mA Zone has reached the alarm threshold. The value must exceed the Alarm Limit to trip an alarm.

Table Low: The Table Low value is used to define the lower range (4mA) of your 4-20mA sensor.

Sentinel Pro Installation and Setup Guide

Table High: The Table High value is used to define the upper range (20mA) of your 4-20mA sensor.

Alarm Delivery Enable/Disable: When Enabled, alarm messages will be delivered, if set to Disabled alarm messages will not be delivered.

Recognition Time: This is the length of time that an alarm condition must be present before a valid alarm exists and message delivery is started.

Alarm Hold Time: When an alarm occurs, the *Alarm Hold Time* will latch the alarm condition for the programmed time period, thus preventing redundant alarms from sending additional notification messages. This is useful for alarms that are likely to trip several times within a short time period, such as motion detectors.

Return to Normal Enable/Disable: This feature instructs the Sentinel Pro to send a message when a zone input has changed from an alarm condition back to a normal condition. Anyone who received the original alarm message will also be sent the Return-to-Normal message.

Auto Acknowledge Enable/Disable: Enabling this option will automatically acknowledge an alarm when the zone goes back to normal. As a result, all remaining alarm notifications will be cancelled.

Alarm Reset Enable/Disable: This setting enables or disables the Alarm Reset Feature. The Alarm Reset feature is used to re-send alarm messages in the event that a fault condition is not corrected in a timely fashion. If an alarm continues to exist for the duration of the programmed Reset Time (see below) the alarm will reset (reactivate) and the alarm message delivery process will begin all over again. This is an optional feature.

Alarm Reset Time: This is the time allowed for an alarm's fault condition to be corrected before the Sentinel Pro resets (reactivates) the alarm and begins the message delivery process all over again. It is recommended that this be set to no lower than 30 minutes to prevent numerous messages from being sent.

Datalogging Mode: The Sentinel Pro has two modes of data logging for each zone: Continuous or While In Alarm. In Continuous mode the unit will log the value of the input on a fixed time interval all the time. The Normal Interval sets the logging rate while the value is within the normal range. The Alarm Interval sets the logging rate while the value is an alarm condition. By choosing the While In Alarm mode you can choose to have the unit only log values when it exceeds the alarm limits.

Alarm Datalog Interval: This is the interval that data will be logged while the input is beyond the programmed alarm limits. (Note: this is regardless of the programmed Alarm Recognition Time).

Normal Datalog Interval: This is the interval that data will be logged while the input is within the programmed alarm limits. To maximize the available memory for datalogging, set the Datalog Interval for each zone to multiples of each other. For example, Zone 1 can be set to 10 minutes, Zone 2 to 30 minutes, Zone 3 to 60 minutes, etc...

MANAGE USERS

The sensaphone.net website allows you to set up users that will be linked to your account. Each user can be configured to have their own login for website access and/or be contacted for alarms. In addition, you can choose to give alarm acknowledgement capability to each user.

There are several levels of permissions that can be assigned to each user. You can also enter contact information for alarm delivery purposes. From the main menu, select *Users*, then *Manage Users*. To add a new user, click on the *Add User* button. The example below shows a user setup as an administrator with four contact destinations.

User Details

[View All Users](#) * = Required Input Field

User Enable Enable Disable

Site Access

Alarm Delivery

User Information

User information is kept private and is for your use only. We will never sell or disclose this information for any purpose.

User Name *

Start typing an address for autocompletion... powered by Google

Address Line 1

Address Line 2

City

State/Subdivision

Postal Code

Country

Contact Details [Add Contact](#) [User Schedule](#)

Description	Type	Destination *	Enable	
Joe's Office	Phone	(888)555-1234	Yes	Schedule Delete
Joe's Cell	Text	333-777-2222	Yes	Schedule Delete
Joe's Home	Phone	(111)888-4444	Yes	Schedule Delete
Joe's Work Email	Email	jmchenry@mycompany.com	Yes	Schedule Delete

Login Details

Email *

Password *

The following defines the various permission levels:

Administrator – Full site access, all devices on your account

Supervisor – Gives the user access to the Dashboard, device-specific pages (for example, Device Details), Manage Users, and Manage User Groups, but for only the devices you choose for them (chosen under the Device Groups section of the form). Supervisors will have the ability to create new users, but they can only give the users Supervisor access or lower.

User – Gives the user access to the Dashboard, but only shows the devices you choose for them (chosen under the Device Groups section of the form)

None – No access to the website

Alarm Delivery – Choose whether you would like the user to be able to receive alarm notifications or not.

Disabled – No alarm delivery

Inform Only – User is notified about the alarm, but cannot acknowledge it

Allow Acknowledgement – User is notified about the alarm and is able to acknowledge it

User Information

Next, enter details about this user. The user's name is the only required information.

Contact Details

The 'Contact Details' section is where you enter the telephone numbers, text numbers, and email addresses to send alarm messages. See sample programming in the figure above. To add additional contacts click "Add Contact". Be sure to add all of your possible contact methods in this section. You can choose which ones get used on the Default Alarm Delivery Schedule or Zone Alarm Delivery Schedule.

Telephone Number Programming

A '1' at the beginning of the telephone number is not required for calls to the USA, Canada, or other countries that are part of the North American Numbering Plan (NANP). See list below:

Countries in the North American Numbering Plan:

- United States
- Canada
- Caribbean Islands
 - Anguilla, Antigua & Barbuda, The Bahamas, Barbados, Bermuda, British Virgin Islands, Cayman Islands, Dominica, The Dominican Republic, Grenada, Jamaica, Montserrat, Saint Kitts and Nevis, Saint Lucia, Saint Vincent and the Grenadines, Sint Maarten, Trinidad and Tobago, Turks & Caicos
- U.S. Territories
 - American Samoa, Guam, Northern Mariana Islands, Puerto Rico, U.S. Virgin Islands*

*Technically some of these are not in North America, but since they are part of the U.S., they use the U.S. telephone system.

For all other countries you have to enter an exit code first (+ or 011), then the country code, and then the number. Do not include trunk codes which are typically displayed as (0) near the beginning of the number.

- For example, a call to the UK could be programmed as either:

+44 20 7950 4631

or

011 44 20 7950 4631

You can also create a time schedule to limit when you'll receive alarm messages. There is an overall *User Schedule* as well as individual Schedules for each contact. The default setting for all schedules is enabled, 24/7. In the sample screen below, the highlighted section shows the times when this user will be contacted for alarms:

User Schedule

[← Back to User](#)

User: Joe McHenry

Account Timezone: Eastern Time

Please configure the schedule during which the user's contacts are available to receive alarms.

Available:

24/7

Custom Time Ranges

Tips: Click and drag down to create a time range. Click an existing time range to edit it. [Clear Schedule](#)

Time Range Options

Repeat this time range on these days:

Sunday

Monday

Tuesday

Wednesday

Thursday

Friday

Saturday

Edit the start and end time:

Start: 5:00am

End: 3:00pm

[Okay](#) [Delete](#)

	Sunday	Monday	Tuesday	Wednesday	Thursday	Friday	Saturday
12am							
1am							
2am							
3am							
4am							
5am		5:00-3:00 Time Range	5:00-3:00 Time Range	5:00-3:00 Time Range	5:00-3:00 Time Range	5:00-3:00 Time Range	
6am							
7am							

*Note that if you configure both a User Schedule and individual Contact Schedules, there must be overlap in order for alarm messages to be delivered.

Login Details

Users will login with an email address and password. Enter this information in the *Login Details* section. In the event that a user forgets his/her password they can use the reset password feature on the main login page.

Device Access

For accounts with multiple users and/or devices, you can choose to limit a user's access to selected devices. In the *Device Access* section, choose which units this User can access. See sample screen below:

Device Access

Administrators have access to all devices and groups.

<input checked="" type="checkbox"/>	 Acme Wet Well Alarm
<input checked="" type="checkbox"/>	 PHL Water Plant
<input checked="" type="checkbox"/>	 River Road Pump Station
<input type="checkbox"/>	 Valley Forge Booster Station
<input type="checkbox"/>	 Acme WasteWater Treatment Plant

Click on 'Save Changes' once you are finished.

MANAGE USER GROUPS

Allows you to set up groups of users that can be used on other site pages.

Select the group you wish to edit from the dropdown menu, or select *Create New Group* to make a new group.

Make sure to give each group a unique, descriptive name so they can be easily referenced.

Click on the plus icon to add users to the group. A pop up modal window will show that will list all the alarm users you have added to your account from the Manage Users page (see that page description for more information).

You can select an entire user (all destinations listed under that user at the time of the alarm will be notified) or individual destinations of the user.

Click on the red X icon to remove that user from the group.

Once you are finished adding and removing users, click on the *Save Group* button at the bottom of the page.

ALARM DELIVERY

The Alarm Delivery section is where you configure the people that will be contacted when an alarm occurs. You can setup a *Default Alarm Delivery Schedule* (i.e. contact list) for each device or you can create a separate *Zone Alarm Delivery Schedule* for each individual zone. A combination of both can also be used (e.g. some zones use the default schedule and others use a custom schedule). The first step is to configure your Users and Contacts as described in the *Manage Users* section. If you haven't completed that step please do it first.

Default Alarm Delivery Schedule

To get started select a device from the Dashboard and click *Details*. Next click the *Default Alarm Delivery* button. Click the *Add Destination* button to select people from your User list. You can select all of the User contacts or just a few if desired. See sample screen below:

The screenshot displays the 'Default Alarm Delivery' configuration interface. At the top, there are navigation tabs: 'Device Details', 'Configure Device', 'Default Alarm Delivery', and 'Device Logs'. Below this, it indicates '3 Delivery Destinations'. The main section is titled 'Delivery Escalation Tiers' and includes a 'Delete Schedule' button. A description states: 'Configure who gets contacted when an alarm condition is detected.' There are three tiers listed:

- Tier 1:** Initial delivery immediately after alarm detected. It lists three contacts for 'Frank Johnson': a text message to 888-777-5555, an email to frank.johnson@mycompany.com, and a work email to frank@mycompany.com.
- Tier 2:** Time Delay of 15 minutes. It lists three contacts for 'Joe McHenry': a phone call to 888-555-1234, a text message to 333-777-2222, and an email to joe@mycompany.com.
- Tier 3:** Time Delay of 30 minutes. It lists two contacts for 'Joseph Smith': a text message to 555-222-7788 and an email to joseph@mycompany.com.

Continue clicking the *Add Destination* button to add additional User's to the list. If you would like to insert a delay between the first User (or group of Users) and the next User, click the *Add Tier* button and enter the delay time. Users in this Tier will not be contacted until the delay time expires. Click *Save Changes* when your schedule is complete.

*Note that the Tier Delay timer starts at the time the alarm occurs. If the alarm is acknowledged before the delay time expires then Users in the 2nd Tier (and beyond) will not receive the alarm message. See sample programming screen below:

Default Alarm Delivery - Sentinel Demo

Device Details | Configure Device | **Default Alarm Delivery** | Device Logs

Add Delivery Destinations to Tier 1

Quick-add Destinations:
Quickly add a destination not associated with a user to the delivery tier.

Description	Type	Destination	
<input type="text"/>	Text	Ex: 215-555-1234	<input type="button" value="Remove"/>

Users:
Select users and/or user contacts to add to the delivery tier.

- Frank Johnson
 - Frank Johnson Text - 888-777-5555 (Text)
 - Frank Johnson Cell - 888-777-5555 (Phone)
 - Frank Johnson Work Email - frank@mycompany.com (Email)
- Joe McHenry
 - Joe's Office - (888)555-1234 (Phone)
 - Joe's Cell - 333-777-2222 (Text)
 - Joe's Home - (111)888-4444 (Phone)
 - Joe's Work Email - jmchenry@mycompany.com (Email)
- Joseph Smith
 - Cell Phone - 555-222-7788 (Text)
 - Work Email - jsmith@mycompany.com (Email)
- Kate Marshall

Zone Alarm Delivery Schedule

A Zone Alarm Delivery Schedule is an alarm contact list that only applies to one specific zone. You can create a separate Zone Alarm Delivery Schedule for each individual zone if required. To configure a *Zone Alarm Delivery Schedule* select a Zone from the *Device Details* page. Then click the *Zone Alarm Delivery* tab on the right. Select *Custom* to configure a contact list for the selected zone. Follow the steps as described above to complete the schedule.

Quick-Add Destinations

Quick-Add Destinations are those that can be easily entered to the notification list without creating a User Account. Note, however, that destinations added here will be inform-only (e.g. **cannot acknowledge alarms**). This entry method is useful for sending messages to people who do not require a user account in the system but may want to be informed when a particular alarm occurs.

Alarm Acknowledgment

Alarms can be acknowledged from the dashboard page by selecting a device using the checkboxes next to each device, and then clicking the “Action” drop-down at the top of the screen. You can acknowledge both Device Offline alarms or Zone alarms. Devices with ‘Unacknowledged’ alarms are identified with an exclamation point within a triangle. Once the alarm is acknowledged this symbol will disappear. You can acknowledge multiple alarms on multiple devices at the same time. Alarms can also be acknowledged during telephone calls by entering 555 when prompted, or by clicking the web link contained in email and text messages.

LOGS

The Sentinel Pro includes an Alarm Log and Data Log. The Alarm Log lists all alarm activity for the selected device. You can narrow down the messages by individual zones or you can select multiple zones. The Data Log contains the recorded values for each zone based on the parameters you set up on the Zone Configuration screens. You can display the values on the screen as well as graph them. There is also an option to Save the data to a file. To get to the Device Logs section, click the *Details* button from the Dashboard for the device you would like to view, then click the *Device Logs* button.

Sentinel Pro Installation and Setup Guide

Alarm Log – Shows the history of all alarm notifications that were sent for the device

Data Log – Show the history of all logged zone values and statuses for the device

Export Data - Allows you to save selected Alarm Log or Data Log records in either CSV or pdf format. Note that CSV formatted files can be opened in Microsoft Excel.

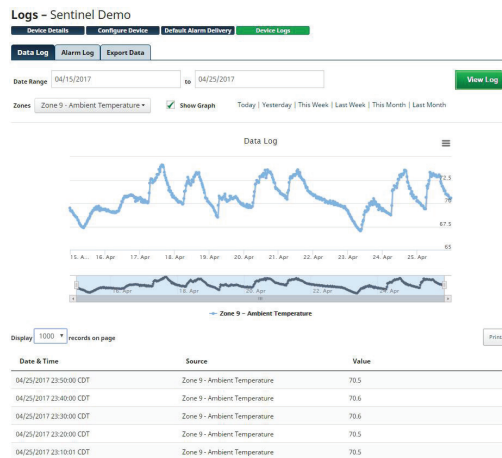

Note that for Normally Open and Normally Closed zone types, the Sentinel will record a “0” when the input is presented with an open circuit and a “1” when the input has a closed circuit. Depending on your sensor and programming, this may represent either a normal or alarm condition.

DEVICE MANAGEMENT

You can add, modify, and remove Sentinel devices from your account on the Manage Devices screen. From the main menu select Admin, then Manage Devices. Listed below are the device-related actions that can be done.

Adding Devices - To add a new device to your account, enter the device serial number (located on the bottom of the unit in the format 00:07:F9:00:00:00) and give the device a name, then click *Add Device*.

Reboot Device - To reboot your device, select it from the list to the left and then choose Reboot Device from the drop down box at the bottom of the page, then click Submit. Your Sentinel will reboot and then reconnect within a few minutes. Your Sentinelgramming will remain intact.

Remove From Account - To remove a device from your account, select it from the list to the left and then choose Remove from Account from the drop-down box at the bottom of the page. Then click *Submit*.

Reset to Default Values - To reset a device to default settings, select it from the list to the left and then choose *Reset to Default Values* from the drop-down box at the bottom of the page. Then click *Submit*. Allow several minutes for your device to complete the reset process.

Manage Devices

Your Devices

- Acme Wet Well Alarm - 00-07-F9-00-70-B1
- PHL Water Plant - 00-07-F9-00-71-88
- River Road Pump Station - 00-07-F9-00-71-80
- Valley Forge Booster Station - 00-07-F9-00-82-5D
- WasteWater Treatment Plant - 00-07-F9-00-82-F9

With Selected: Reset to Default Values

Submit

Add a Device

Serial Number

Device Name

Add Device

DEVICE GROUPS

In cases where you have many devices and many users it may be desirable to create Device Groups. These can make it easier to assign device permissions to specified Users. From the main menu select Admin, then Device Groups. In the main window, you will see a list of all your devices and any groups you may have already created. Devices are shown with a green device icon and groups are shown with a black icon. You can have multiple groups, and you can even have groups within a group. If a device icon is lined up on the left-most side of the window, they are not in a group.

To add a new group, click on the Add Group button at the top of the page. A 'New Group' icon will appear in the list. You can rename the group by right clicking on it and selecting Rename. To move a device into a group, click on the device and drag it into the group. Continue adding devices until you're finished, then click Save Groups.

The blue number shown on the group icon shows how many devices are within that group. To remove a group, right click on the group and select Delete. Any devices in that group will be moved up one level. For example, if a group that had two devices was deleted, the two devices would be shifted to the left and would no longer be in any group. You can also click and drag a device or group to reorder them. To search through your devices click on Filters. You can choose to hide any device or group that does not match your search, and you can choose to only search through your devices and not your groups. Once you are finished editing your groups, click on the Save Groups button at the bottom of the page.

ACCOUNT SETTINGS

The Account settings page is used to configure a number of options that apply across the board to your account. This page is only available to users with 'Admin' site access level. To access the account page select 'Admin' from the main menu, then 'Account'.

NAME: Give your account a 'Name' that best describes the organization managing your devices.

TIME ZONE: Set the 'Time Zone', which will serve as the default for all of your users. This will be important to ensure that any schedules you configure will operate at the appropriate times.

There are several 'Account Features' that you can configure to have the system operate in a certain manner.

REQUIRE SITE USER: When Admins and Supervisors are configuring Users, you can force the system to require that all User's receive website access by checking the 'Require Site User' box.

REQUIRE ALARM USER: Similarly, you can also require all Users to have the ability to receive alarm notifications by checking the 'Require Alarm User' box.

USER GROUPS: You can choose whether or not to allow 'User Groups' to be created within the system. Check the 'User Groups' check box to permit user groups to be used within the system.

HIDE DISABLED ALARMS: On the device details page you choose to hide the alarm status of a zone if 'Alarm Delivery' is set to disabled for the selected zone. This can be convenient when a zone is beyond the alarm limits for maintenance reasons and you don't want to display the status as 'Alarm'.

CSV Email: Enabling this setting exposes an option on the User pages to use the CSV email message format used by some state department of environmental protection agencies (such as the MASS DEP). Note that enabling this option will expose a similar setting on the User pages so that you can create a specific user with a specific email address to receive the specially formatted message.

CHAPTER 3: CONFIGURING THE RELAY OUTPUTS

The Sentinel Pro includes two relay outputs that can be used to control a light, siren, or other low voltage device. The output can be configured to switch either manually or automatically when a zone changes state or exceeds the alarm limits. To program the output click *Output* from the *Device Details* or *Configure Device* screen. The following configuration page will appear:

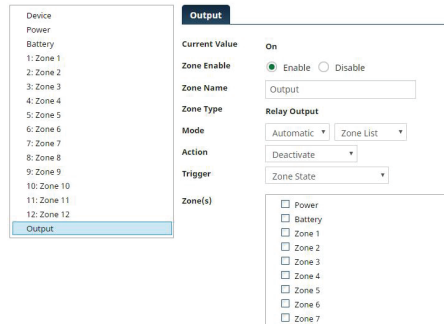

Enter a Name so that you'll know what the Output will be controlling. The Output can operate in Manual mode or Automatic mode. In manual mode you can turn the relay ON or OFF through the web page or the mobile App. To manually switch the relay output, click in the State field and select either ON or OFF, then click *Save Changes*. The change request will be sent to the Sentinel and the *Current Value* will update after the output change has successfully completed.

In Automatic mode the relay can be programmed to turn-on automatically when certain conditions are met. Listed below is a description of the parameters that apply to the automatic modes.

Input Selection - Next to the Automatic mode selection box is another drop-down that allows you to select which zones will control the output. There are four options (Zone List, Type List, All Inputs, and Limit: Zones).

Zone List: This option allows you to individually select which zones will cause the output to switch. Check the boxes next to the desired zones.

Type List: This option allows you select zones based on the zone Type. For example, you could have all of the zones configured for Temperature control the output.

All Inputs: This option selects all of the inputs (zones).

Limit: Zones: This option allows you to independently control the output based on the value of one or two zones using greater-than, less-than, or equal-to comparison statements. A separate Output-On and Output-Off instruction can be configured with its own comparison value. See sample below:

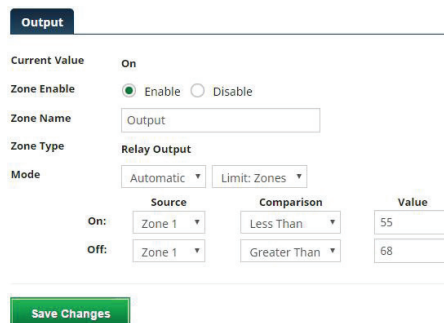

Action - This setting determines what the Output will do when the selected zone (or zones) exceeds the alarm limits. You can have the relay Activate (turn-on), Deactivate (turn-off), or Cycle (ON under normal conditions, momentarily OFF for 10 seconds when an alarm condition occurs, then back ON).

Trigger - The trigger determines what will cause the output to change state. There are 3 options to choose from which are described below:

Unacknowledged Alarms: Choosing this option will make the Output change to the setting defined by the Action for as long as an Unacknowledged Alarm persists on the selected zones. Once the alarm is acknowledged the Output will revert back to its normal position.

Alarm Condition: Choosing this option will make the Output change to the setting defined by the Action for as long as the selected input(s) remain in Alarm, regardless of acknowledgement. Once the selected zones return to their normal state the Output will revert back to its normal position.

Zone State: Choosing this option will make the output change to the setting defined by the Action as soon as the selected zones exceed the alarm limits. In other words, the alarm recognition time is not enforced, and the Output will change instantly. Once the selected zones return to their normal state the Output will revert back to its normal position.

Relay Output Wiring

The relay output can be used to turn on a light, siren, or other low voltage device. The relay is rated for up to 30VAC/VDC 1 Amp. A sample wiring diagram is shown below:

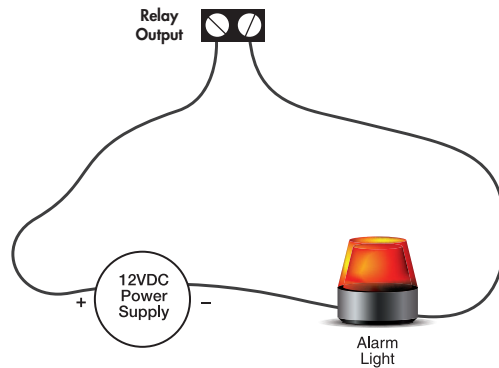

CHAPTER 4: MODBUS

The Sentinel Pro can be configured to read up to 64 Modbus registers from any modbus device so that you can create alarms, view the values over the internet, and record the values for trending purposes. The Sentinel can read the values over 2-wire RS485 or Ethernet/TCP. You can also read registers from both interfaces simultaneously, if desired. Once you have configured the unit to read the registers you can create alarm set points, view the current values on the website, scale the value using multiplication or division, add units of measure, and also record the values in the unit's datalogger.

READING MODBUS OVER RS485

To read values from a Modbus device over RS485 the Sentinel Pro must be the Modbus Master. All other devices must be configured as Modbus Slaves. The Sentinel Pro can read from multiple slave devices as long as the baud rate is the same among all connected devices and there are no overlapping register addresses.

Connect the Sentinel Pro and your Modbus device(s) as shown in the figure below:

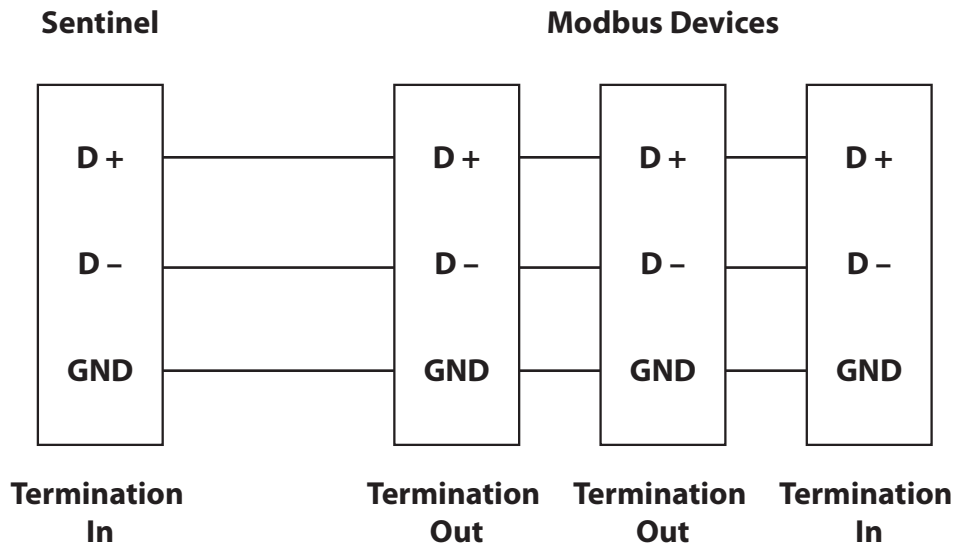

Connect the ground terminal (GND) on the Sentinel Pro RS485 terminal strip to the corresponding ground or shield terminal on the Modbus slave device. Connect the Sentinel Pro RS485 Transmit/Receive Positive (D+) terminal to the corresponding positive data terminal on the Modbus slave device. Connect the Sentinel Pro Negative (D-) terminal to the corresponding negative data terminal.

Next, go to the *Configure Device* page on the Sensaphone.net website. Scroll down to the Modbus RS-485 Settings and configure the parameters to match your Modbus device. See sample figure below:

Modbus RS-485 Settings

Mode	Master ▾
Baud Rate	19200 ▾
Parity	None ▾
Stop Bits	1 ▾

Click the *Save Changes* button when finished.

To query data from a network-based Modbus device using ModbusTCP, go to the Configure Device page and scroll down to the *Modbus TCP Settings* section. Set the Mode to Master, then click *Save Changes*.

Modbus TCP Settings

Mode

The next step is to add a Modbus Zone. Locate the Zone list on the left side of the Device Configure page. At the top of the list click *Add Zone*, then select *Modbus*. See screen picture below:

Configure Device - My Sentinel Pro

The screenshot shows the 'Configure Device - My Sentinel Pro' page. At the top, there are tabs for 'Device Details', 'Configure Device', 'Default Alarm Delivery', and 'Device Logs'. Below these, there are two main sections: 'My Sentinel Pro' and 'Offline Alarm Delivery'. The 'Add Zone' dropdown menu is open, showing a list of zone types: 'Modbus', 'Power', 'Battery', 'Lithium Battery', and '1: Zone 1'. The 'Modbus' option is highlighted. To the right of the dropdown, the device's serial number (00-07-F9-00-80-84), firmware version (v.1.6.40), and subscription status (Free) are displayed.

A Modbus Zone will be added to the bottom of the zone list and the *Modbus Zone Configure* page will appear to the right.

The screenshot displays the 'Modbus Zone Configure' page for 'Branch CT Size 75'. The page is divided into several sections:

- Current Value:** 90.00 Amps
- Zone Name:** Branch CT Size 75
- Zone Type:** Modbus Input
- Custom Units:** Amps
- Alarm Low:** 0
- Alarm High:** 100
- Alarm Delivery:** Enable (checked)
- Alarm Delivery Settings:**
 - Recognition Time: 0 hours, 0 minutes, 3 seconds
 - Alarm Hold Time: 0 minutes, 1 seconds
 - Return to Normal: Enable (checked)
 - Alarm Reset: Enable (checked), 2 hours, 0 minutes
- Datalog Settings:**
 - Mode: Continuous (checked)
 - Alarm Interval: 0 hours, 5 minutes
 - Normal Interval: 0 hours, 30 minutes
- Modbus Settings:**
 - Interface Type: RS-485
 - Slave ID: 1
 - Address: 75
 - Command: (3) Read Holding Registers
 - Data Format: 16-bit Integer
 - Register Size: 16-bit
 - Byte Order: Big Endian
 - Sign: Unsigned
 - Scaling Operand: 1
 - Scaling Offset: 0

 A 'Save Changes' button is located at the bottom of the page.

MODBUS ZONE SETUP

The Sentinel Pro can be configured to read from almost any modbus slave device and data format through the correct selection of the settings described below. Attention to detail is vital when setting up a modbus zone. If any of the below settings are not correct, the Sentinel Pro will fail to retrieve the data from the slave device or will read incorrect values. If you are unsure of the correct setting, refer to the user's manual for the device you are trying to connect to. The various zone configuration settings are explained in detail below.

Current Value: 7.500 Ft.
Zone Name: Well Level
Zone Type: Modbus (Analog)
Custom Units: Ft.

Zone Type: The Sentinel Pro can read analog or digital values from Modbus registers. Set the 'Zone Type' to match the type of value being read. The choices are (1) Modbus (Analog), (2) Modbus (Digital, Normally Zero), and (3) Modbus (Digital, Normally Non-Zero). Select option 2 or 3 if the register you are reading from only has two possible values. Choose 'Digital Normally Zero' if the register gives a value of 0 when conditions are normal. Choose 'Digital Normally Non-Zero' if the register gives a value of 1 or some other non-zero number when conditions are normal, and 0 when an alarm/fault exists.

Current Value: Running
Zone Name: Pump 1 Status
Zone Type: Modbus (Digital, Normally Zero)
Custom Units: Z: Stopped / NZ: Running

Custom Units: If you selected Modbus Analog then you may enter any text that describes the value, such as: Degrees, %RH, Feet, Gal, PSI, GPM, FPM, Volts, Amps, Watts, etc... If you select Modbus Digital you can have different text display for each digital value. The Custom Units drop-down lets you select from several preconfigured options (e.g. OK/Alarm, Open/Closed, On/Off, Running/Stopped). The first word will display if the value is zero (Z) and the second word will display if the value is 1 or non-zero (NZ). You can also enter your own custom words by selecting 'Custom' at the top of the list and entering your own words in the box to the right, such as [Wet/Dry].

Interface Type: TCP, TCP, RS-485

Interface Type: Select the appropriate physical interface for your external device. Choose between:

TCP: Modbus Communication over Ethernet port on the Sentinel Pro. The slave devices from which data is to be read be able to communicate to the Sentinel Pro over the LAN connection.

RS-485: Modbus Communicate over RS-485 using the terminal block located on the Sentinel Pro.

Slave ID: 1

Slave ID: Unique number which identifies the Modbus slave device on the network. All slave devices on an RS-485 network must have a unique address (1-255). If necessary, refer to the manual of your modbus slave device to determine how to changes the slave ID, also referred to as the slave address.

Host: 192.168.1.1

Host: (TCP devices only) IP address of slave device from which data is to be read.

Port: 502

Port: (TCP devices only) Port on which the slave device will send and receive modbus traffic. Typically, this will be on port 502.

Address Hexadecimal

Command
 (1) Read Discrete Outputs
 (1) Read Discrete Outputs
 (2) Read Discrete Inputs
 (3) Read Holding Registers
 (4) Read Input Registers

Address: Register address of the value you want to read from your Modbus slave device. Only enter the base portion of the register address (i.e. if the address is listed as 400100, only enter 100). Note that if the address is entered in Hexadecimal format, it will be displayed in decimal format the next time the zone settings page is viewed for that zone.

Command: Select the appropriate command to issue to the Modbus server device based on the register type to be read.

(1) Read Discrete Outputs: Use this command to issue a modbus function code 1 in order to read a discrete output from the Modbus server. A Discrete Output is a single bit in size (on/off) and may sometimes be referred to as a “coil”

(2): Read Discrete Inputs: Use this command to issue a Modbus function code 2 in order to read a discrete input register from a Modbus server. A discrete input is a single bit data type (on/off).

(3) Read Holding Register: Issue a modbus function code 3 in order to read a holding register.

(4) Read Input Register: Issue a modbus function code 4 in order to read an input register.

A note on determining the correct modbus command: *Often, the required command is not explicitly stated in the manufacturer’s documentation for a modbus device; however the proper function type can be determined from the register’s address. The first (most significant) digit in the address often indicates which command to use. Refer to the table below:*

Address Range	Select Modbus Function Command:
000000-065536	(1) Read Discrete Output
100000-165536	(2) Read Discrete Input
400000-465536	(3) Read Holding Register
300000-365536	(4) Read Input Register

Data Format
 8-bit Integer
 8-bit Integer
 16-bit Integer
 32-bit Integer
 Single Precision Float

Data Format: Select the proper value based on the format being sent from the slave device. The Sentinel Pro supports four data types, they are as follows:

“8-bit Integer”: Integer value 8 bits in length, configurable as signed or unsigned. If this value is read from a register that is greater than 8-bits in size, only the 8 least significant bits are used, the rest are ignored.

“16-bit Integer”: Integer value 16 bits in length, configurable as signed or unsigned. If the register size is set to “8 Bit”, the register at the address specified and the next register (address + 1) will be combined to form a 16-Bit value.

“32-Bit Integer”: Signed integer value 32 bits in length, it can be signed or unsigned. If the register size is set to “8 Bit”, the register at the address specified and the contents of the next 3 registers will be combined to form a 32-Bit value. If a register size is set to “16-bit” then the register at the address specified and the contents of the next register (address + 1) will be combined to form a 32-bit value.

“32-Bit Float”: Single precision floating point value. If the register size is set to “8 Bit”, the register at the address specified and the contents of the next 3 registers will be combined to form a 32-Bit floating point value. If register size is set to “16-bit” then the register at the address specified and the contents of the next register (address + 1) will be combined to form a 32-bit floating point value.

Register Size

Register Size: Specifies the size (in bits) of each register that the slave device is sending to your Sentinel Pro. A register size of 16 bits is the de-facto standard however the Sentinel Pro will also support registers of 8 and 32 bits in size.

Byte Order

Byte order: Modbus registers that are multiple bytes in size can be arranged in either Big Endian or Little Endian format. Big endian is sometimes referred to as network byte order and little endian is sometimes referred to as Intel byte order. If Big-Endian is specified, the Sentinel Pro will always interpret the first byte sent in a Modbus data packet as the most significant byte and the last byte sent as the least significant byte. If Little-Endian is specified, the first byte read in each register will be interpreted as the least significant and the last byte read will be interpreted as the most significant byte.

Register Order

Register Order: In cases where the size of the data type being read is greater than the register size, multiple registers must be read to form a complete value. For example, if one wishes to read a floating point value at address location 1 from a device with 16-bit modbus registers, the registers at addresses 1 and 2 must be combined to form the complete value. The register order specifies how these registers are ordered to create the final value. If “Big Endian” is specified, the first register read (lowest address) by the Sentinel Pro is interpreted as the highest order value and the last register read (greatest address) is interpreted as the lowest order value. Little endian specifies that the first register read contains the least significant byte(s) and the last register contains the most significant byte(s).

Sign

Data Representation:

Scaling Operand

1

Multiplier

Scaling Offset

0

Data Representation: Values read from Modbus devices can be processed by the Sentinel Pro using the following options:

Sign: Select “Signed” if the value you are reading uses 2’s compliment notation to represent negative values. Select “Unsigned” if no sign data included in the value.

Scaling Operand: (Integer values only) Use this option to have the value read multiplied or divided by a specified factor. For example, many Modbus devices used a fixed-point integer notation to represent a value. Use Divisor operand to display the value with the decimal point in the correct place.

Scaling Offset: This function allows for the read value to be offset by a fixed amount. Note that the offset is applied after the scaling operation (if applicable).

CONNECTING MODBUS RS-485 DEVICES TO YOUR SENTINEL PRO

RS-485 is a standard communication interface that consists of a differential pair of wires and an optional ground lead. Multiple slave devices can be connected on the same pair of communication wires to form a communication bus with a length up to 4,000 feet (1,200M). A maximum of 255 uniquely addressed slave devices can be connected to the same bus. However, due to hardware limitations usually it is not advisable to exceed more than 32 devices on the same network. This is not a hard limit and varies based upon the load applied to the Sentinel Pro by the third party devices and how well the physical network is set up. The Sentinel Pro itself presents a 1/8 load to the network.

When planning an RS-485 network, several design guidelines should be considered in order to ensure an optimal signal between your Sentinel Pro and Modbus slave devices on the RS-485 bus. Following the guidelines described below is especially important for long signal runs and/or with many devices connected to the same bus.

Suggested Cable Type:

The table below gives suggested specifications for the cable used to connect the Sentinel Pro to other Modbus RS-485 devices. The closer the cable you choose matches these specs, the more likely it is that your Sentinel Pro will be able to communicate to other modbus devices without error. Please note the though the ground connector is not required by the RS-485 standard, it is strongly recommended that it be used in your network.

Type	Shielded twisted pair with an additional ground conductor
Wire Gauge	18-24 AWG
Characteristic Impedance (Twisted Pair)	120 Ohm
Shunt Capacitance	16 pF/feet or below
Propagation Velocity	66% or greater

Sentinel Pro (Master)

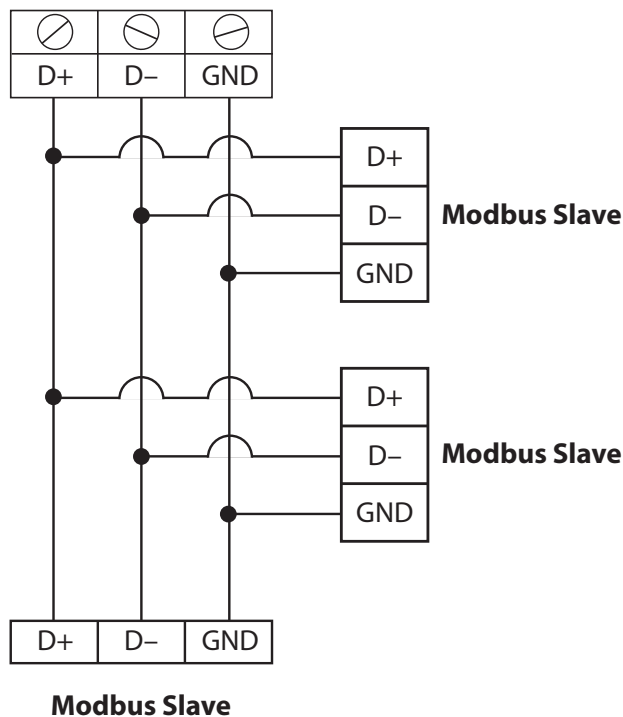

The image to the left represents the basic layout of a properly wired RS-485 network. Your RS-485 network should consist of a single main cable “trunk.” Never run multiple long runs to each modbus slave device. Termination resistors should be placed between the two communication conductors at each end of the main run, but nowhere else. The value of the termination resistors should match the characteristic impedance of the cable you are using. If your Sentinel Pro is at one end of the run, its internal termination resistor can be used by setting the “Bus Term.” Switch next to the RS-485 terminal block to the “In” position. If your Sentinel is not at the end of the main run then set this switch to the “Out” position. If the devices at the ends of the main run do not have an internal termination resistor, an external one must be used. A standard 1/4W, 5% resistor is adequate.

Many times, it may not be possible to have all devices along the main run and a short cable stub must be spliced into the main run to attach a device. Make every effort to make the stub runs as short as possible. If this stub length is greater than approximately 22 feet (6.7m), the main cable should be re-routed so as to make the stub shorter. It's always better to have a longer main run and shorter stub lengths. Also, make sure that all devices connected to the main run, whether via a stub or directly, are adequately spaced apart along the cable. Make sure there is at least 18 inches (0.5m) of cable between all devices and splices on the data bus. If necessary, make the main run longer to meet this requirement.

MODBUS COMMUNICATION ALARMS

In the event that your Modbus device stops communicating with the Sentinel PRO due to power failure, disconnected cable, or device malfunction, etc... the Sentinel Pro will send a Modbus zone not responding alarm. Messages sent via email will include a list of the affected registers. Voice and text messages will identify the faulty Modbus device by either its IP address (for TCP devices) or SlaveID (for RS485 devices). Only one alarm will be triggered for an unresponsive Modbus device, regardless of the number of Modbus registers being monitored. Unresponsive devices will display a status of 'Not Responding' for each Modbus zone on the device details page of the website.

APPENDIX A: WEEKLY TESTING PROCEDURE

We recommend that you test your Sensaphone weekly to be sure it is functioning properly. This will ensure that when a problem arises the Sensaphone will be ready to alert the appropriate personnel.

There are several tests that can be performed:

1.) Create an alarm on each zone by tripping all connected sensors.

Temperature sensors: Heat or cool the sensor.

Motion sensors: Have someone walk in front of the sensor.

Door/window sensors: open the door/window.

Water sensors: Apply a small amount of water beneath the sensor or use a wet towel and touch it to the sensor probes.

Humidity sensors: Raise the humidity around the sensor by holding a cup of very hot water beneath the sensor.

2.) Allow the unit to contact all programmed users. This will make sure that the Sensaphone is programmed properly. It will also prepare personnel to respond appropriately when they receive a message from the Sensaphone.

3.) Test the battery (if installed) by unplugging the AC adapter and making sure that the Sensaphone continues to function. Keep the AC adapter unplugged so that a Power Failure alarm occurs. Plug in the AC adapter after the unit has finished.

4.) Keep a log of your tests, noting the date and whether the Sentinel Pro passed in each category tested. An example of such a log is shown below. (See “Test Log” at the end of this manual.)

Date	Inputs		Alarm		Battery		
	Pass	Fail	Pass	Fail	Pass	Fail	
07/19/09	<input checked="" type="checkbox"/>	<input type="checkbox"/>	<input checked="" type="checkbox"/>	<input type="checkbox"/>	<input checked="" type="checkbox"/>	<input type="checkbox"/>	Bob H
08/20/09	<input checked="" type="checkbox"/>	<input type="checkbox"/>	<input checked="" type="checkbox"/>	<input type="checkbox"/>	<input checked="" type="checkbox"/>	<input type="checkbox"/>	Alex G.
09/19/09	<input checked="" type="checkbox"/>	<input type="checkbox"/>	<input checked="" type="checkbox"/>	<input type="checkbox"/>	<input checked="" type="checkbox"/>	<input type="checkbox"/>	Bob H.
	<input type="checkbox"/>	<input type="checkbox"/>	<input type="checkbox"/>	<input type="checkbox"/>	<input type="checkbox"/>	<input type="checkbox"/>	
	<input type="checkbox"/>	<input type="checkbox"/>	<input type="checkbox"/>	<input type="checkbox"/>	<input type="checkbox"/>	<input type="checkbox"/>	

If you require assistance, call Sensaphone Technical Support at 610-558-2700.

APPENDIX B: ACCESSORIES

The sensors listed below are available from Sensaphone, and represent the most commonly used zone devices. Other dry contact sensors, designed for more specialized applications, may also be used. Commercial or industrial electrical supply houses can provide devices to monitor virtually any condition. For further information, contact Sensaphone Customer Service at 610-558-2700.

PART #	SENSOR / SWITCH
BAT-0032	Sentinel Pro Battery
BAT-0005	Cellular Modem Battery
FGD-0006	Magnetic Reed Switch
FGD-0007	Passive Infra-Red Detector
FGD-0010	50' two-conductor #22AWG shielded Cable
FGD-0013	Spot Water Detector
FGD-0022	Temp° Alert
FGD-0027	Humidistat
FGD-0049	Smoke Detector with Built-in Relay
FGD-0052	Humidity 4-20mA Transmitter
FGD-0053	24VDC Power Supply
FGD-0054	Power-Out Alert™
FGD-0056	Zone Water Detector w/Water Rope
FGD-0063	Additional 10' Water Rope for FGD-0056
FGD-0065	Carbon Monoxide Sensor
FGD-0066	Air Quality Sensor
FGD-0067	Surge Suppressor
FGD-0100	2.8k Remote Temperature Sensor
FGD-0101	2.8k Weatherproof Temperature Probe
FGD-0102	10k Weatherproof Temperature Probe
FGD-0103	10k Indoor Decorator
FGD-0104	10k Outdoor Air Weatherproof

APPENDIX C: SPECIFICATIONS

ALERT ZONES

Number of Zones: 12

Zone Connector: terminal block

Zone Types: N.O./N.C. contact, 2.8K Thermistor (-109° to 115°F, -85° to 57°C) And 10K Thermistor (-87° to 168°F; -66° to 76°C), and 4-20mA (-80,000.0 to 80,000.0

Zone Characteristics: 28.7KΩ to 3.3V (temperature/contact) or 250 Ohms to ground (4-20mA)

A/D Converter Resolution: 12 bits ±2 LSB

Zone Protection: 5.5VDC Metal Oxide Varistor with fast acting diode clamps.

Pulse Counting: 1ms minimum duration, 1 pulse-per-second maximum rate

RELAY OUTPUT

Rated for 1A 30VAC/ 1A 30VDC Maximum

DATA LOGGING

5 minutes to 1 month sampling rate

User programmable channel selection

Zones 1 – 12

Battery

Input Power

LED INDICATORS

Power: On steady when the unit is powered on.

Alarm: Off when no alarm exists.

Ethernet Link and Activity LEDs

Online

Standby

COMMUNICATION TYPE:

4G/LTE Cellular via AT&T, Verizon, or Rogers

POWER SUPPLY

Power Supply: 120VAC/12VDC 50/60Hz 30W wall plug-in transformer w/6' cord.

Power Consumption: 15 Watts

Power Protection: Metal Oxide Varistor

BATTERY BACKUP

Rechargeable Battery: Internal 8 Hr NiMH Battery Pack (Part # BAT-0032)

Memory/Clock Battery: Internal 5-10 yr CR2 lithium (Part # BAT-0033)

Cellular Battery: 3AH SLA Battery (Part-0005)

ENVIRONMENTAL

Operating Temperature: 32–122° F (0–50° C)

Operating Humidity: 0–90% RH non-condensing

Storage Temperature: 32°–140° F (0–60° C)

PHYSICAL

Dimensions: 14 x 12 x 7.4" (356mm x 305mm x 188mm)

Weight: 14 lbs. (6.35 kg)

APPENDIX D: THERMISTORS

2.8K THERMISTOR DATA

Degrees Celsius	Resistance (Ohms)
-50	187,625
-40	94,206
-30	49,549
-20	27,180
-10	15,491
0	9,142
10	5,572
20	3,498
30	2,256
40	1,491
50	1,009
60	697
70	490
80	351

10K THERMISTOR DATA

Degrees Celsius	Resistance (Ohms)
-50	441.3K
-40	239.8K
-30	135.2K
-20	78.91K
-10	47.54K
0	29.49K
10	18.79K
20	12.25K
30	8,194K
40	5,592
50	3,893
60	2,760
70	1,990
80	1,458
90	1,084
100	816.8
120	481.8
130	376.4
140	297.2
150	237.0

APPENDIX E: POST & CONNECTION ERROR CODES

When the device boots up it runs a Power On Self Test (e.g. POST). During this process the Online LED will go through a series of blink patterns. This can take a few minutes while it tests various functions and connects to the Sensaphone.net servers. If a problem occurs, the Online LED will blink a repetitive pattern of 'x' blinks followed by a 5 second pause. The table below defines the possible errors based on the number led of blinks.

Online LED Blink Codes	Failure indication	Description	Corrective Action?
OFF	Idle	Unit does not have a secure connection to the server, nor attempting to establish a secure connection	"Unit is initializing, either on power-up or rebooting. Most of the initial boot time is spent initializing memory, which can take a few minutes. * If the power LED is also OFF, the unit may have its power cable disconnected and its internal battery is depleted. * A less likely possibility is the online LED is disconnected or faulty."
flickering	Negotiating	Unit is negotiating a secure connection	The online LED flickering or blinking irregularly is normal when the unit is negotiating the secure connection. In contrast, the error code blinks steadily, then has a 5 second OFF period between error blinks.
ON	Connected	Unit has established a secure connection with the server	Secure connection with the server is established – OK!
1	Operating system initialization in progress	The unit's operating system's I/O is initializing	There is a fault in the firmware if this error code persists.
2	Real-time clock initialization failed	Internal clock not functioning	Possibly a hardware fault with the processor's internal RAM or RTC oscillator failure
3	Ethernet device initialization failed	Failed to configure ethernet chip	Probably a hardware fault.
4	Ethernet cable failed	Ethernet cable appears to be disconnected during boot	The Ethernet cable may be disconnected or otherwise faulty
5	DHCP failed	Unable to bind IP address	If using static IP, there may be an error in the IP, DNS, gateway or netmask. If using DHCP, problem may be with DHCP server.
6	Secure negotiation in progress	The unit's operating system's I/O has finished initializing, will now proceed with the secure connection negotiation	"There is a fault in program execution if this error code occurs, perhaps the memory has been corrupted. * A less likely possibility is the processor's internal RAM is faulty."
7	DNS link failed	DNS link failed	"DNS address may be incorrect, or perhaps the DNS server is down. Also check the Ethernet cable: if disconnected while securely connected to the server, reconnection attempts while the cable is disconnected will fail here."
8	IP address failed	IP address could not be resolved	If using static IP, the IP address may be incorrect
9	TCP socket failed	TCP socket to the secure server failed to connect	Port 443 may be blocked. Or perhaps the remote server is unavailable – this is the first attempt at connecting with the remote server. Will attempt to reconnect to another server.
10	SSL connect failed	SSL connection to the secure server failed to connect	Server may have SSL disabled?
11	SSL handshake failed	SSL handshake failed	If this keeps happening, the problem may be the server has changed its SSL certificate.

Appendix E: POST & Connection Error Codes

12	Server dropped the connection	The server dropped the established secure connection for some reason	Probably a glitch. Unit will reestablish the secure connection in a minute. (This is the catch-all error code for the server dropping the connection – there are many possible reasons).
13	SSL invalid MAC	The server dropped the established secure connection due to an invalid MAC	Probably a glitch, unit will reestablish the secure connection in a minute.
14	TCP read error	The server dropped the established secure connection due to a read error	Probably a glitch. Unit will reestablish the secure connection in a minute. If this keeps occurring, the server may be restarting/rebooting and may take about 8 minutes to reconnect.
15	Ethernet cable disconnected	The Ethernet cable disconnected or failed while the secure connection was established	Reconnect or replace the Ethernet cable
16	Reserved		
17	TCP write error	The unit had a problem transmitting over Ethernet	Probably a glitch. Unit will reestablish the secure connection in a minute. If this keeps occurring, there may be a problem with the real-time clock getting stuck - check if the lithium battery is below 30% (2.3V; nominal voltage is 3.0V).
18	TCP socket closed	The TCP socket between the unit and the server is unexpectedly closed.	Unit will reboot if this error occurs 6 times, which may clear the problem. Manual reboot would be the equivalent.
19	HTTP JSON parse error	The JSON message from the server is garbled or not present	Corrupt data communication. If a cellular or satellite connection, check for weak signal

APPENDIX F: RETURNING THE UNIT FOR REPAIR

In the event that the Sentinel Pro does not function properly, we suggest that you do the following:

- 1) Record your observations regarding the Sentinel Pro's malfunction.
- 2) Call the Technical Service Department at 610-558-2700 prior to sending the unit to Sensaphone for repair.

If the unit must be sent to Sensaphone for Servicing, please do the following:

- 1) Unplug the AC power supply from the wall outlet and disconnect all sensors from the alert zones.
- 2) Carefully pack the unit to avoid damage in transit. Use the original container (if available) or a sturdy shipping box.
- 3) You must include the following information to avoid shipping delays:
 - a) Your name, address and telephone number.
 - b) A note explaining the problem.

- 4) Ship your package to the address below:

SERVICE DEPARTMENT

SENSAPHONE

901 Tryens Road

Aston, PA 19014

- 5) Ship prepaid and insured via UPS or US Mail to ensure a traceable shipment with recourse for damage or replacement.

